



# LIGHTING & ELECTRICAL

## FEATURING

**NEW** Edgeless Ultra Bright Light Bars  
*See pg. 22 - 23*

**NEW** LED Flood Light with Strobe Series  
*See pg. 14 - 15*

**Round and Oval  
Stop/Turn/Tail/Backup/Strobe Lights**  
*See pg. 68*



WORK | WARNING | DOT

**NOTHING WORKS LIKE A DOGG™**

# Our History



Buyers Products Company founded by Sam Ruven and Bessie Kleinman as a distributor of driveline components.



Buyers continued to grow its product offerings and build valued relationships with customers and suppliers. Increased demand for products led to the pursuit of supply chain manufacturing solutions.



1992 Buyers acquired Trailer Components Manufacturing (Tracom) for CNC precision machining and tooling, as well as state-of-the-art welding.



1995 Buyers acquired Progressive Powder Coating. Our Nordson automatic powder application booth is used to powder coat our Buyers toolboxes and other truck and trailer accessories.



2002 Buyers moved its corporate headquarters to a brand new 235,000 sq. ft. state-of-the-art office and distribution center.



2004 Buyers acquired Romotech in New Paris, Indiana. Our Ferry Industries Rotospeed molding machines are used to manufacture our poly salt spreaders.



2007 Buyers began manufacturing the SnowDogg stainless steel snowplow at our Mentor, Ohio facility.



2009 Buyers began our operations at Boomerang Rubber, in Botkins, Ohio manufacturing mudflaps, wheel chocks and other rubber truck and trailer accessories.



2013 Buyers acquired an additional 500,000 sq. ft. manufacturing facility in Mentor, Ohio allowing for expansion of our aluminum and stainless steel manufacturing.



2016 Buyers establishes a 22,000 sq ft Engineering Tech Center in Mentor, Ohio. It's multi-use lab, design, training and prototyping space is dedicated to the research and development of innovative product.

**ALL YOUR WORK TRUCK PRODUCTS ALL THE TIME.**

2017 Buyers launches new website with business partner portal, to make online ordering and account maintenance easy for customers.



2021 Buyers adds almost 300,000 sq ft of additional, state-of-the-art warehouse and office space to maintain the quick turnaround and competitive value their customers expect.

## Our Corporate Family of Companies



Founded in 1946, Buyers Products is a fully integrated manufacturer and a leader in the truck equipment industry. Our engineering, manufacturing and assembly operations take place in the USA, under the Buyers family of companies. **Buyers Products' mission is to improve our Customers' profitability and productivity while enhancing the quality of our products and services.**





















# TABLE OF CONTENTS

<b>WORK LIGHTS</b>	<b>2</b>	<b>DOT LIGHTS</b>	<b>78</b>
Round Lens Flood and Spot Lights	4-7	License / Utility Plate Lights	103-104
Square Lens Flood and Spot Lights	8-19	Reflectors and Conspicuity Tape	105
LED Flood Lights with Strobe	14-15	Spreader Light Bar Kits & Light Boxes	106-113
Specialty Mount Lights	20-21	<b>OBSERVATION SYSTEMS &amp; ACCESSORIES</b>	<b>114</b>
Flood/Spot Light Bars	22-27	Backup Cameras	114-117
LED Strip Lights	28-29	Camera Accessories	116-117
Interior Lights	30	<b>ROADSIDE ASSISTANCE EQUIPMENT</b>	<b>118</b>
<b>PLOW LIGHTS</b>	<b>32</b>	Booster Cables	118
Heated LED Plow Lights	34-35	Road Strobe/Flares	119
Dual Beam Halogen Headlamps	35	Towing Lights & Backup Alarms	120
<b>WARNING LIGHTS</b>	<b>36</b>	<b>ELECTRICAL ACCESSORIES</b>	<b>121</b>
Modular Light Bar & Accessories	38-41	Switches & Switch Panels	121-125
LED Light Bars	42	Circuit Breakers	126
LED Mini Light Bars	43-47	Solenoids and Motors	127-128
Light Bar Mounts and Cab Mounts	48-49	Meters, Battery Adapters	129-130
Traffic Advisors	50-51	Junction Boxes & Fuse Holders	130-131
Strobe Lights	52-69	<b>MERCHANDISE</b>	<b>132</b>
Combination Stop/Turn/Tail/Backup Strobe Lights	68	Counter Mats	132
Beacon Lights	70-76	Light Displays	133-135
Beacon Accessories	77	<b>GLOSSARY - INDEX</b>	<b>136</b>
<b>DOT LIGHTS</b>	<b>78</b>	Lighting Regulations	136-143
Marker/Clearance Lights	80-85	Industry Glossary & Icon Definitions	144-145
Stop, Turn & Tail Lights	86-94	Warranty Policy	146
Turn Signal Lights	95-98	Numerical Index	147-148
Backup Lights	99-102		

## ICON KEY ————— Refer to page 145 for more details

 Limited Lifetime Warranty	 12 Volts	 IP65 Rated	 IPX6 Rated	 SAE J595 Class 1
 1 Year Warranty	 12-24 Volts	 IP66 Rated	 IPX7 Rated	 SAE J845 Class 1
 5 Year Warranty	 PC Rated	 IP67 Rated	 IPX8 Rated	 CA13
		 IP68 Rated	 IP69K Rated	

## NEW PRODUCTS

<p><b>Edgeless Work Lights and Combination Work Lights</b> Pages 13 &amp; 14</p> 	<p><b>48" Wireless Light Bar with Traffic Advisor</b> <b>4.5" Horizontal Dual Color Strobe Lights</b> Page 42 &amp; 53</p> 	<p><b>Drill Free Mount</b> Page 47</p> 
<p><b>Round and Oval Stop/Turn/Tail/Backup/Strobe</b> Page 66</p> 	<p><b>Round and Oval Stop/Turn/Tail/Backup Lights</b> Pages 87 &amp; 90</p> 	<p><b>Micro Beacon</b> Page 71</p> 



# WORK





# WORK LIGHTS





## Ultra Bright 5" LED

5-YEAR  
**W**  
12-24  
VOLTS  
IP  
67

Number of LEDs	14
Lumens	3,780
Lead Length	18"
Mount / Base	10mm Stud, SST



Part No.	Type	Color	Amp	Connection	Wt. (lbs.)	Cat.
1492127	Flood	Clear	1.83	Blunt Cut	1.49	562 (N)

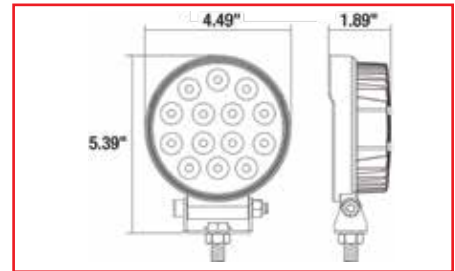
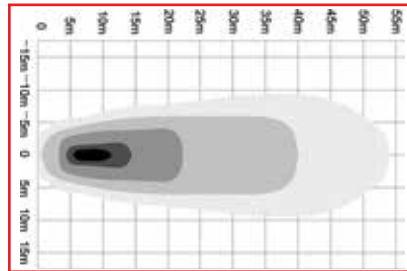

## 4" LED

5-YEAR  
**W**  
12-24  
VOLTS  
IP  
67

Number of LEDs	9
Lumens	1,710
Lead Length	18"
Mount / Base	8mm Stud, SST



Part No.	Type	Color	Amp	Connection	Wt. (lbs.)	Cat.
1492114	Flood	Clear	1.25	Blunt Cut	1.58	562 (N)

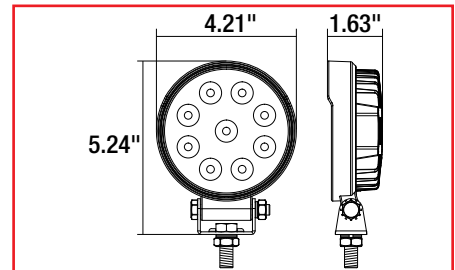
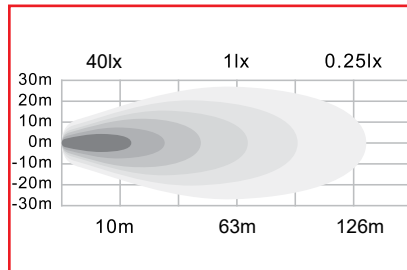

## 4" LED Magnetic Base

5-YEAR  
**W**  
12-24  
VOLTS  
IP  
67

Number of LEDs	6
Lumens	1,140
Lead Length	30'
Mount / Base	Magnetic



Part No.	Type	Color	Amp	Connection	Wt. (lbs.)	Cat.
1492130	Flood	Clear	1.5	12V DC Adapter	2.53	562 (N)

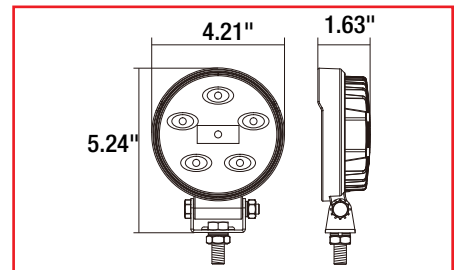
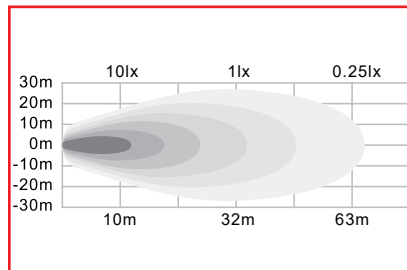

# Work Lights

## 4.5" LED

<b>5-YEAR W</b> <b>12-24 VOLTS</b> <b>IP 67</b>	Number of LEDs	6
	Lumens	1,350
	Lead Length	36"
	Mount / Base	8mm Stud, SST

Part No.	Type	Housing Color	Lens Color	Amp	Connection	Wt. (lbs.)	Cat.
1492115	Flood	Black	Clear	1.5	Blunt Cut	1.20	562 (N)
1492116	Flood	Black	Amber	1.5	Blunt Cut	1.20	562 (N)
1493215	Flood	White	Clear	1.5	Blunt Cut	1.20	562 (N)
1492215	Spot	Black	Clear	1.5	Blunt Cut	1.20	562 (N)

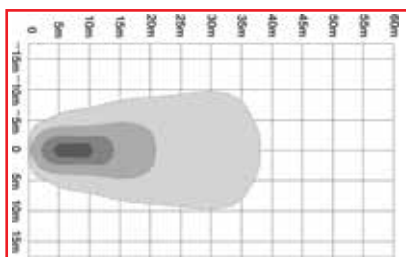
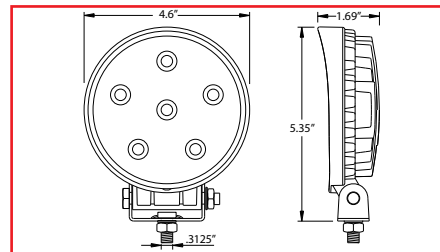
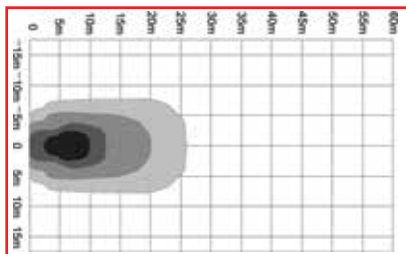

## 5" LED Sealed Rubber

<b>5-YEAR W</b> <b>12-24 VOLTS</b> <b>IP 67</b>	Number of LEDs	6
	Lumens	1,350
	Lead Length	36"
	Mount / Base	8mm Stud SST

Part No.	Type	Color	Amp	Connection	Wt. (lbs.)	Cat.
1492112	Flood	Clear	1.5	Blunt Cut	1.80	562 (N)

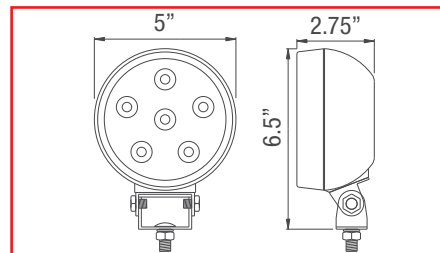
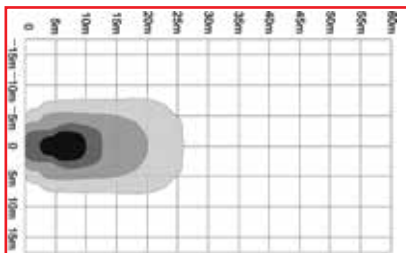

## 5" LED Sealed Rubber

<b>5-YEAR W</b> <b>12-24 VOLTS</b> <b>IP 67</b>	Number of LEDs	54
	Lumens	375
	Lead Length	36"
	Mount / Base	8mm Stud, SST

Part No.	Type	Color	Amp	Connection	Wt. (lbs.)	Cat.
1492110	Flood	Clear	3	Blunt Cut	1.63	562 (N)
1492111	Flood	Amber	3	Blunt Cut	1.63	562 (N)

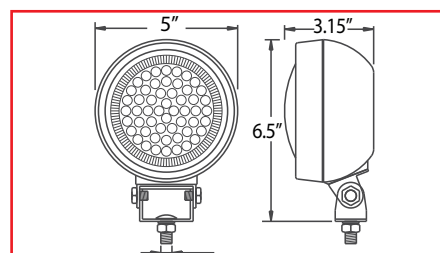
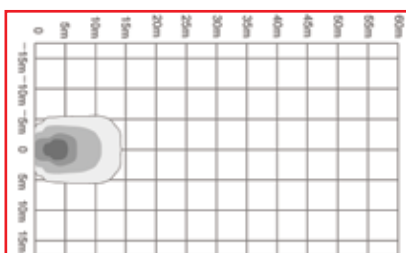



## 5" Incandescent Sealed Rubber

5-YEAR  
**W**  
12  
**VOLTS**  
IP  
**67**

Number of LEDs	-
Lumens	-
Lead Length	10"
Mount / Base	8mm Stud Zinc



Part No.	Type	Color	Amp	Connection	Wt. (lbs.)	Cat.
1492100	Flood	Clear	2.92	Blunt Cut	2.64	562 (N)

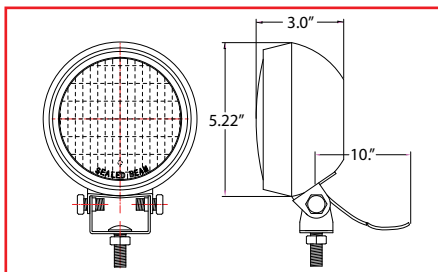

## 5.5" LED

5-YEAR  
**W**  
12-24  
**VOLTS**  
IP  
**67**

Number of LEDs	6
Lumens	1,350
Lead Length	36"
Mount / Base	8mm Stud SST



Part No.	Type	Color	Amp	Connection	Wt. (lbs.)	Cat.
1492113	Flood/Spot	Clear	1.5	Blunt Cut	1.20	562 (N)

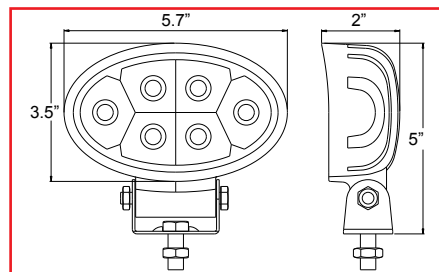
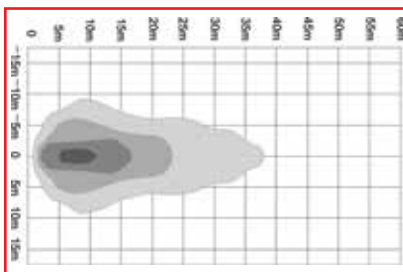

## Stainless Steel Mounts

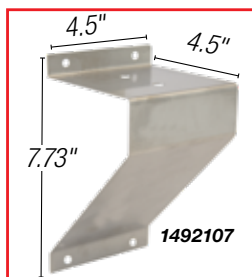
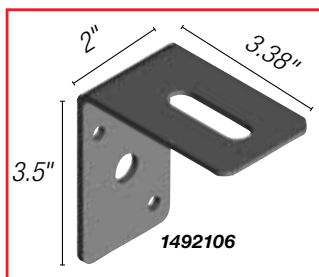

Part No.	Description	Wt. (lbs.)	Cat.
1492106	Stainless Steel Bracket	0.47	562 (N)
1492107	Stainless Steel Bracket	0.90	562 (N)

# Work Lights

## Ultra Bright 3" LED

<b>5-YEAR W 12-24 VOLTS IP 67 IP 69K</b>	Number of LEDs	4
	Lumens	4,000
	Lead Length	20"
	Mount / Base	8mm Stud, SST

Part No.	Type	Color	Amp	Connection	Wt. (lbs.)	Cat.
 <b>1492227*</b>	Flood	Clear	3.55	Deutsch	1.45	562 (N)

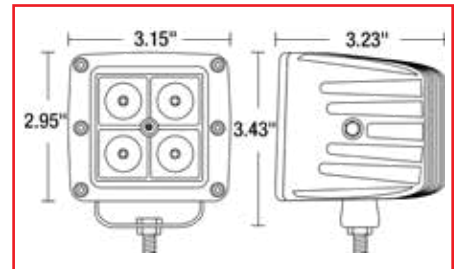
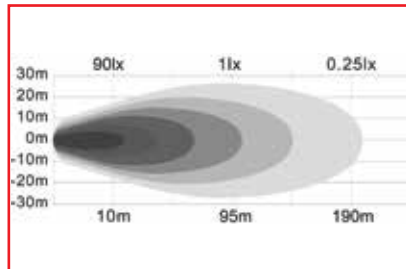

## Ultra Bright 4" LED

<b>5-YEAR W 12-24 VOLTS IP 67</b>	Number of LEDs	21
	Lumens	12,600
	Lead Length	9"
	Mount / Base	10mm Stud, SST

Part No.	Type	Color	Amp	Connection	Wt. (lbs.)	Cat.
 <b>1492223</b>	Flood	Clear	7.75	Deutsch	2.34	562 (N)

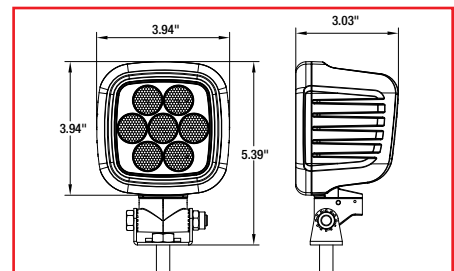
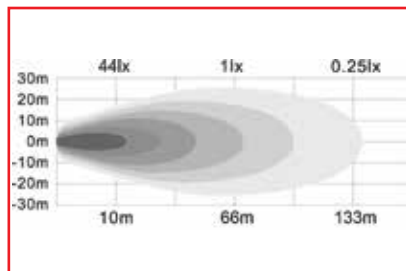

## Ultra Bright 4" LED with Heated Lens

<b>5-YEAR W 12-24 VOLTS IP 67 IP 69K</b>	Number of LEDs	4
	Lumens	4,500
	Lead Length	7"
	Mount / Base	10mm Stud, SST

Part No.	Type	Color	Amp	Connection	Wt. (lbs.)	Cat.
 <b>1492198*</b>	Flood	Clear	6.6	Blunt Cut	3.31	562 (N)

Heated tempered glass lens helps prevent ice from building up.

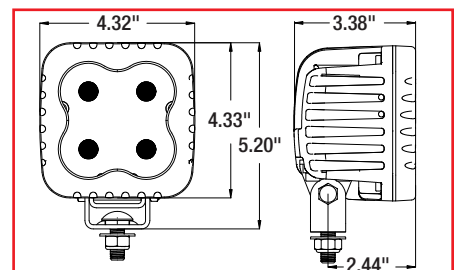
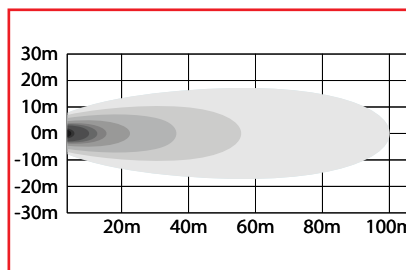



## Ultra Bright Wide Angle 4" LED

5-YEAR  
**W**  
12-24  
VOLTS  
**IP**  
67

Number of LEDs	10
Lumens	3,540
Lead Length	18"
Mount / Base	10mm Stud, SST

Part No.	Type	Color	Amp	Connection	Wt. (lbs.)	Cat.
 1492197	Flood/Spot	Clear	2.18	Blunt Cut	1.73	562 (N)

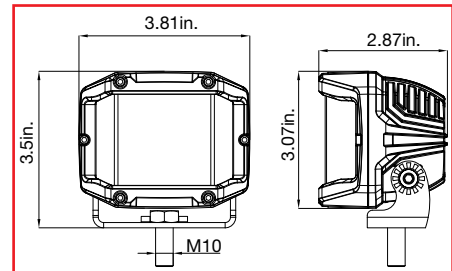
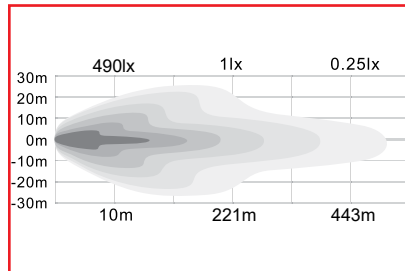

## Ultra Bright 4.5" LED

5-YEAR  
**W**  
12-24  
VOLTS  
**IP**  
67

Number of LEDs	36
Lumens	21,600
Lead Length	28"
Mount / Base	10mm Stud, SST

Part No.	Type	Color	Amp	Connection	Wt. (lbs.)	Cat.
 1492225	Flood	Clear	10.00	Deutsch	2.90	562 (N)

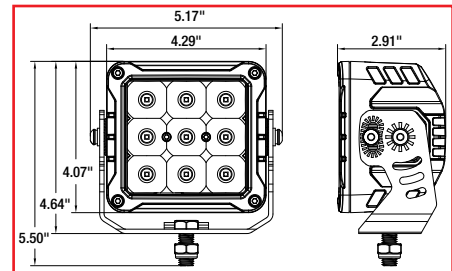
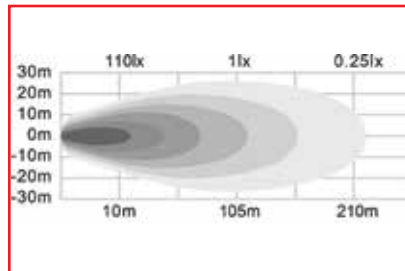

## Ultra Bright 4.5" LED

5-YEAR  
**W**  
12-24  
VOLTS  
**IP**  
67

Number of LEDs	16
Lumens	9,600
Lead Length	28"
Mount / Base	10mm Stud, SST

Part No.	Type	Color	Amp	Connection	Wt. (lbs.)	Cat.
 1492224	Flood	Clear	6.92	Deutsch	3.0	562 (N)

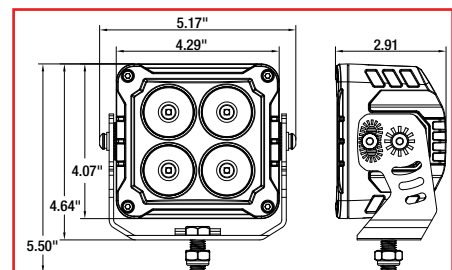
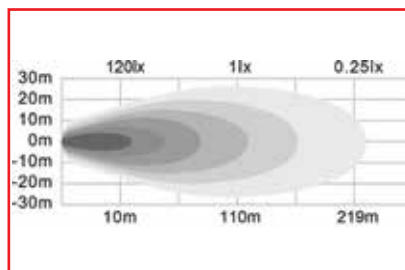

# Work Lights

## Ultra Bright 4.5" LED

<b>5-YEAR</b> <b>W</b> <b>12-24</b> <b>VOLTS</b> <b>IP</b> <b>67</b>	Number of LEDs	16
	Lumens	4,320
	Lead Length	18"
	Mount / Base	10mm Stud, SST

Part No.	Type	Color	Amp	Connection	Wt. (lbs.)	Cat.
 <b>1492128</b>	Flood	Clear	2.08	Blunt Cut	1.66	562 (N)

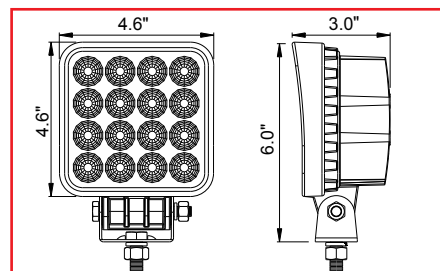
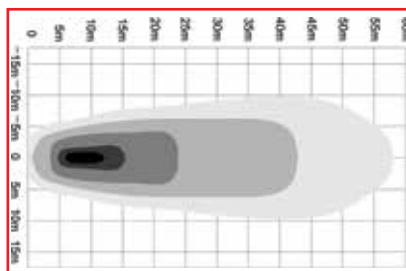

## Ultra Bright 5" LED

<b>5-YEAR</b> <b>W</b> <b>12-24</b> <b>VOLTS</b> <b>IP</b> <b>67</b>	Number of LEDs	17
	Lumens	6,920
	Lead Length	28"
	Mount / Base	10mm Stud, SST

Part No.	Type	Color	Amp	Connection	Wt. (lbs.)	Cat.
 <b>1492222</b>	Flood/Spot	Clear	4.17	Blunt Cut	3.24	562 (N)

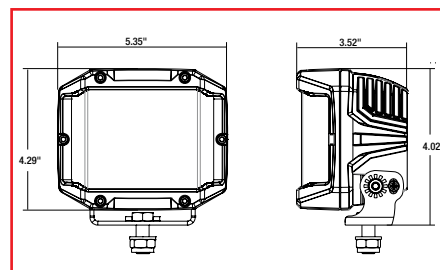
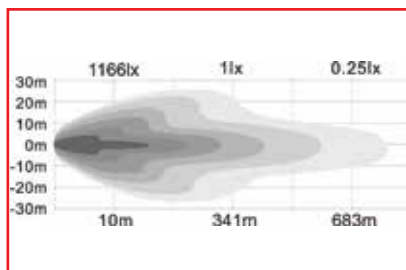

## Ultra Bright 5.5" LED

<b>5-YEAR</b> <b>W</b> <b>12-24</b> <b>VOLTS</b> <b>IP</b> <b>67</b>	Number of LEDs	36
	Lumens	21,600
	Lead Length	9"
	Mount / Base	10mm Stud, SST

Part No.	Type	Color	Amp	Connection	Wt. (lbs.)	Cat.
 <b>1492226</b>	Flood	Clear	12.42	Deutsch	4.6	562 (N)

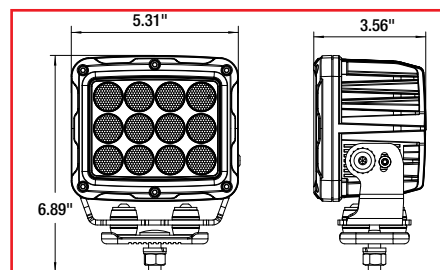
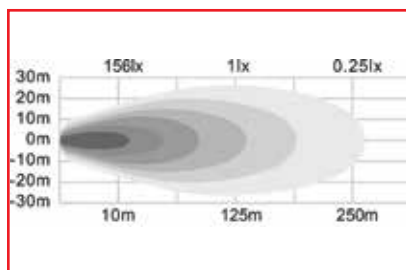

## Ultra Bright 6" LED *Featured on Cover*

5-YEAR  
**W**  
12-24  
VOLTS  
**IP**  
67

Number of LEDs	15
Lumens	9,000
Lead Length	18"
Mount / Base	10mm Stud, SST

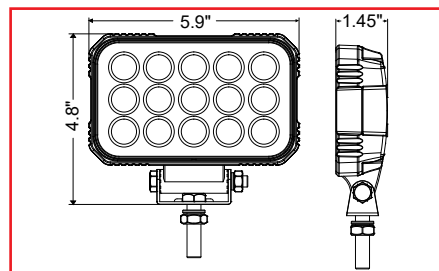
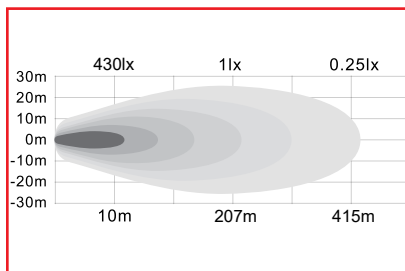

Part No.	Type	Color	Amp	Connection	Wt. (lbs.)	Cat.
 <b>1492196</b>	Flood	Clear	6.8	Blunt Cut	1.6	562 (N)



## Ultra Bright 6" LED

5-YEAR  
**W**  
12-24  
VOLTS  
**IP**  
67

Number of LEDs	15
Lumens	4,050
Lead Length	18"
Mount / Base	10mm Stud, SST

Part No.	Type	Color	Amp	Connection	Wt. (lbs.)	Cat.
 <b>1492190</b>	Flood	Clear	1.96	Blunt Cut	1.6	562 (N)
 <b>1492290</b>	Spot	Clear	1.96	Blunt Cut	1.6	562 (N)

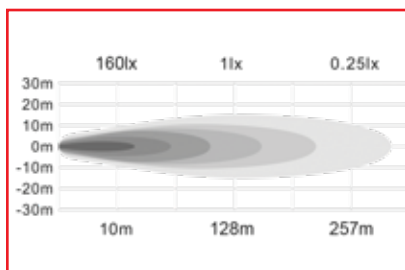
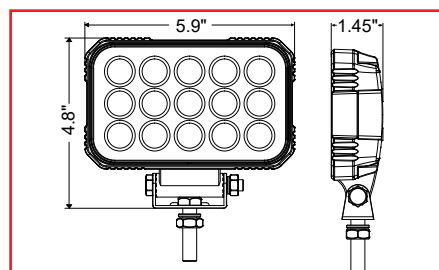
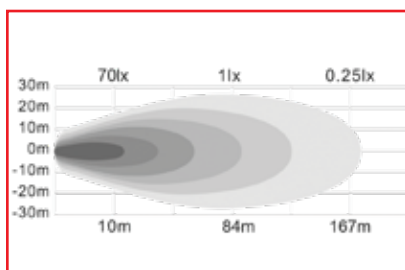



# Work Lights

## Ultra Bright 6.5" LED

<b>5-YEAR W 12-24 VOLTS IP 67</b>	Number of LEDs	36
	Lumens	7,920
	Lead Length	11"
	Mount / Base	10mm Stud, SST

Part No.	Type	Color	Amp	Connection	Wt. (lbs.)	Cat.
 <b>1492194</b>	Flood	Clear	4.9	Blunt Cut	1.88	562 (N)

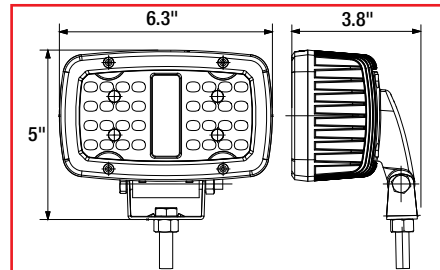
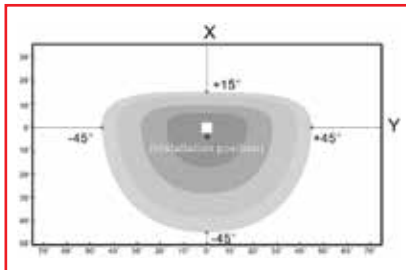

## Ultra Bright 8" LED

<b>5-YEAR W 12-24 VOLTS IP 67</b>	Number of LEDs	20
	Lumens	9,100
	Lead Length	20"
	Mount / Base	Bracket

Part No.	Type	Color	Amp	Connection	Wt. (lbs.)	Cat.
 <b>1492195</b>	Flood/Spot	Clear	5.7	Blunt Cut	4.08	562 (N)

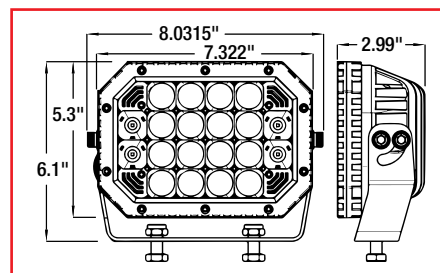
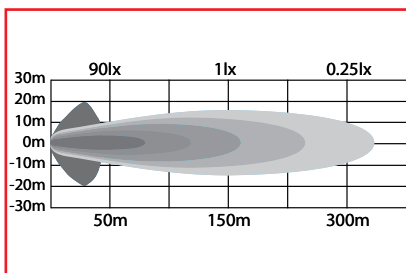

## Ultra Bright 7.5" LED

<b>5-YEAR W 12-24 VOLTS IP 67 IP 69K</b>	Number of LEDs	6
	Lumens	3,600
	Lead Length	20"
	Mount / Base	Recessed

Part No.	Type	Color	Amp	Connection	Wt. (lbs.)	Cat.
 <b>1492228*</b>	Flood	Clear	2.18	Deutsch	1.16	562 (N)

Includes angled mounting bracket.

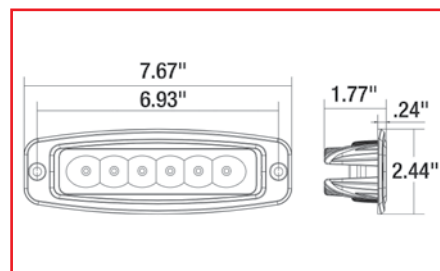
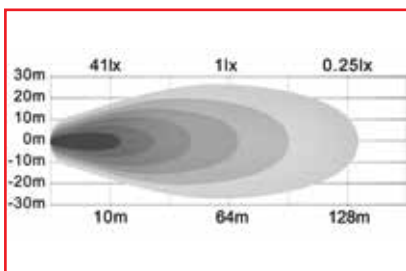

Shown with the included angle bracket



Shown without angle bracket



## Edgeless Ultra Bright 3" LED

5-YEAR  
**W**  
12-24  
**VOLTS**  
IP  
**67**

Number of LEDs	4
Lumens	4,800
Lead Length	18"
Mount / Base	8mm Stud SST

Part No.	Type	Color	Amp	Connection	Wt. (lbs.)	Cat.
 <b>1492236*</b>	Flood	Clear	3.39	Blunt Cut	1.45	562 (N)

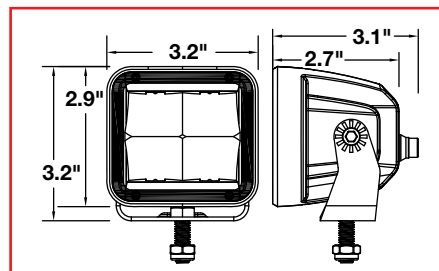
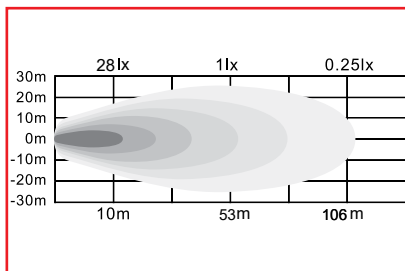

## Edgeless 6" LED

5-YEAR  
**W**  
12-24  
**VOLTS**  
IP  
**67**

Number of LEDs	6
Lumens	2,880
Lead Length	18"
Mount / Base	8mm Stud SST

Part No.	Type	Color	Amp	Connection	Wt. (lbs.)	Cat.
 <b>1492235*</b>	Flood	Clear	2.04	Blunt Cut	1.60	562 (N)

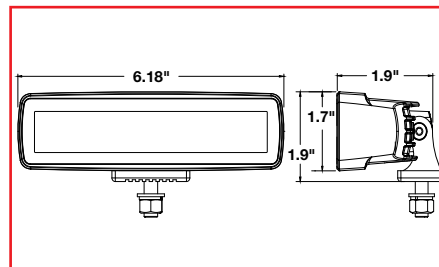
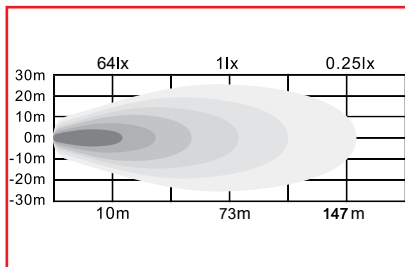

1492235 shown

# Work Lights

## Ultra Bright 4.5" LED with Strobe

<b>5-YEAR W</b>	Number of LEDs	16
<b>12-24 VOLTS</b>	Lumens	9,600
<b>IP 67</b>	Lead Length	20"
<b>IP 69K</b>	Mount / Base	10mm Stud, SST

Part No.	Type - Color	Amp	Connection	Wt. (lbs.)	Cat.
<b>1492230*</b>	Flood - Clear Strobe - Amber	6.67 - Flood 1.33 - Strobe	Deutsch	1.45	562 (N)

Light functions as a bright flood light or a warning strobe light.

**2 LIGHTS IN ONE!**



FLOOD LIGHT

**Strobe Light**



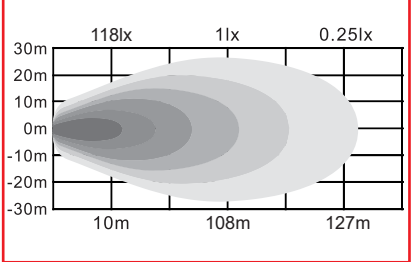

118lx 11x 0.25lx  
30m 20m 10m 0m -10m -20m -30m  
10m 108m 127m

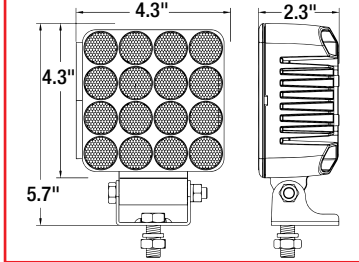

4.3" 2.3" 4.3" 5.7"

## Ultra Bright 4.5" LED with Strobe

<b>5-YEAR W</b>	Number of LEDs	18
<b>12-24 VOLTS</b>	Lumens	4,050
<b>IP 67</b>	Lead Length	18"
<b>IP 69K</b>	Mount / Base	10mm Stud, SST

Part No.	Type - Color	Amp	Connection	Wt. (lbs.)	Cat.
<b>1492231*</b>	Flood - Clear Strobe - Amber	3.7 - Flood 0.8 - Strobe	Deutsch	1.35	562 (N)

Light functions as a bright flood light or a warning strobe light.

**2 LIGHTS IN ONE!**



FLOOD LIGHT

**Strobe Light**



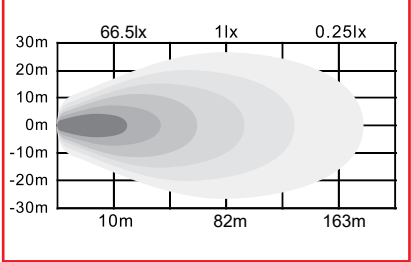

66.5lx 11x 0.25lx  
30m 20m 10m 0m -10m -20m -30m  
10m 82m 163m

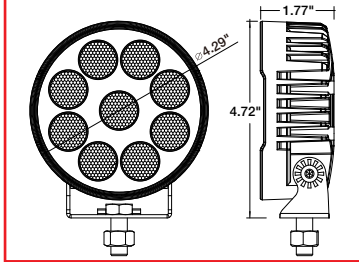

1.77" 4.72" 4.29"

## Ultra Bright 4" LED with Strobe *Featured on Cover*

<b>5-YEAR W</b>	Number of LEDs	10
<b>12-24 VOLTS</b>	Lumens	2,400
<b>IP 67</b>	Lead Length	18"
<b>IP 69K</b>	Mount / Base	10mm Stud, SST

Part No.	Type - Color	Amp	Connection	Wt. (lbs.)	Cat.
<b>1492232*</b>	Flood - Clear Strobe - Amber	1.72 - Flood 0.36 - Strobe	Deutsch	1.30	562 (N)

Light functions as a bright flood light or a warning strobe light.

**2 LIGHTS IN ONE!**



FLOOD LIGHT

**Strobe Light**



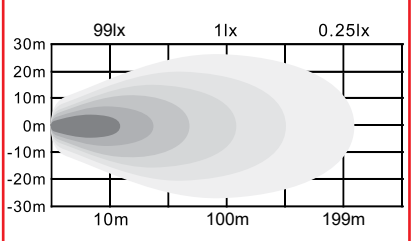

99lx 11x 0.25lx  
30m 20m 10m 0m -10m -20m -30m  
10m 100m 199m

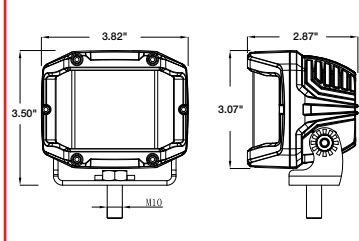

3.82" 2.87" 3.50" 3.07"



## Ultra Bright 6.5" LED with Strobe

5-YEAR  
**W**  
12-24  
VOLTS  
IP  
67  
IP  
69K

Number of LEDs	18
Lumens	1,710
Lead Length	18"
Mount / Base	8m Stud, SST

2  
LIGHTS  
IN ONE!



Part No.	Type - Color	Amp	Connection	Wt. (lbs.)	Cat.
<b>1492233*</b>	Flood - Clear Strobe - Amber	1.27 - Flood 0.21 - Strobe	Deutsch	1.45	562 (N)

Light functions as a bright flood light or a warning strobe light.

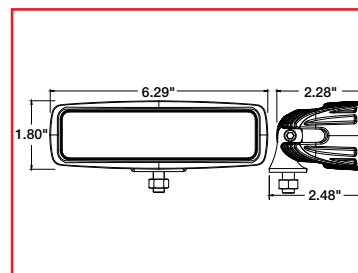
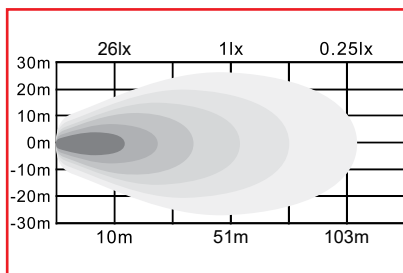

1492232 and 8892202 shown

# Work Lights

## 2.5" LED

<b>5-YEAR</b> <b>W</b> <b>12-24</b> <b>VOLTS</b> <b>IP</b> <b>67</b>	Number of LEDs	4
	Lumens	780
	Lead Length	36"
	Mount / Base	10mm Stud, SST

Part No.	Type	Color	Amp	Connection	Wt. (lbs.)	Cat.
 <b>1492129</b>	Flood	Clear	1.0	Blunt Cut	1.0	562 (N)

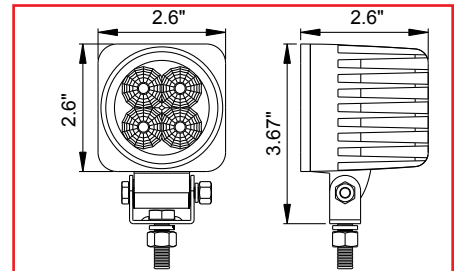
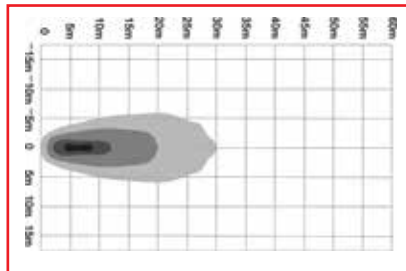

## 3" LED

<b>5-YEAR</b> <b>W</b> <b>12-24</b> <b>VOLTS</b> <b>IP</b> <b>67</b>	Number of LEDs	6
	Lumens	1,620
	Lead Length	18"
	Mount / Base	10mm Stud, SST

Part No.	Type	Color	Amp	Connection	Wt. (lbs.)	Cat.
 <b>1492137</b>	Flood	Clear	1.5	Blunt Cut	1.5	562 (N)

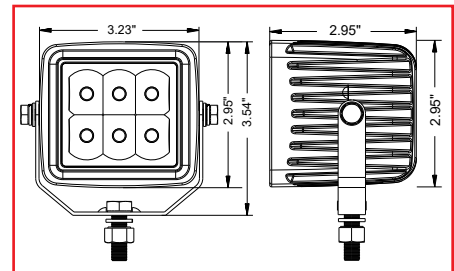
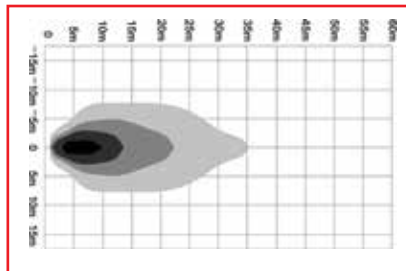

## 3" LED

<b>5-YEAR</b> <b>W</b> <b>12-24</b> <b>VOLTS</b> <b>IP</b> <b>67</b>	Number of LEDs	6
	Lumens	1,380
	Lead Length	36"
	Mount / Base	10mm Stud, SST

Part No.	Type	Color	Amp	Connection	Wt. (lbs.)	Cat.
 <b>1492237</b>	Spot	Clear	1.5	Blunt Cut	1.5	562 (N)

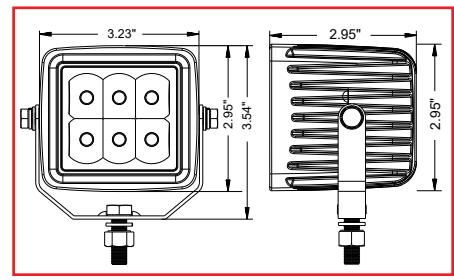
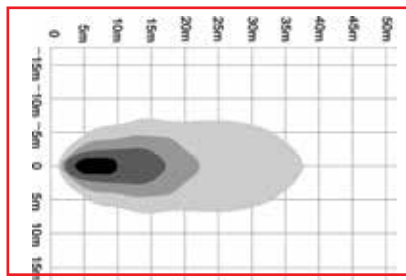

## 4" LED

5-YEAR  
**W**  
12-24  
VOLTS  
**IP**  
67

Number of LEDs	9
Lumens	2,430
Lead Length	18"
Mount / Base	10mm Stud, SST



Part No.	Type	Color	Amp	Connection	Wt. (lbs.)	Cat.
1492134	Spot	Clear	1.25	Blunt Cut	1.12	562 (N)

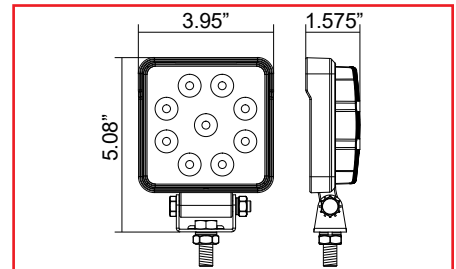
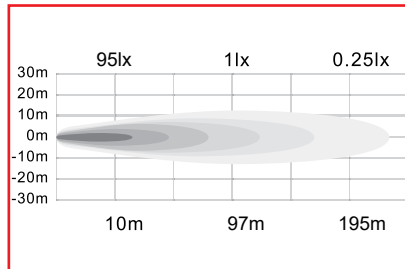

## 4" LED

5-YEAR  
**W**  
12-24  
VOLTS  
**IP**  
67

Number of LEDs	5
Lumens	1,050
Lead Length	36"
Mount / Base	10mm Stud, SST



Part No.	Type	Color	Amp	Connection	Wt. (lbs.)	Cat.
1492117	Flood	Clear	1.2	Blunt Cut	1.20	562 (N)

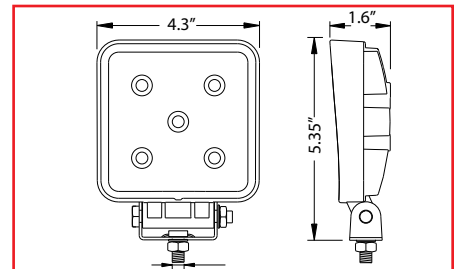
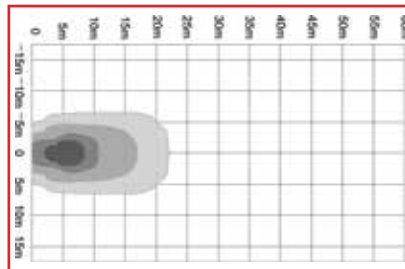

## 4" LED

5-YEAR  
**W**  
12-24  
VOLTS  
**IP**  
67

Number of LEDs	10
Lumens	1,800
Lead Length	14"
Mount / Base	10mm Stud, SST



Part No.	Type	Color	Amp	Connection	Wt. (lbs.)	Cat.
1492220	Flood	Clear	1.0	Blunt Cut	0.90	562 (N)

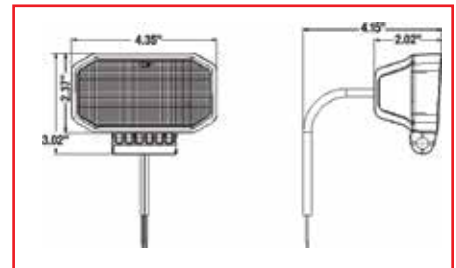
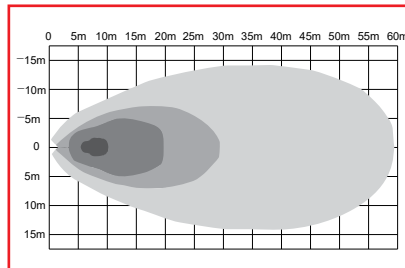



# Work Lights

## 5" LED

<b>5-YEAR</b> <b>W</b> <b>12-24</b> <b>VOLTS</b> <b>IP</b> <b>67</b>	<b>Number of LEDs</b>	9
	<b>Lumens</b>	725
	<b>Lead Length</b>	15"
	<b>Mount / Base</b>	40° Angled

Part No.	Type	Color	Amp	Connection	Wt. (lbs.)	Cat.
 <b>1492199</b>	Flood	Clear	0.75	Blunt Cut	0.79	562 (N)

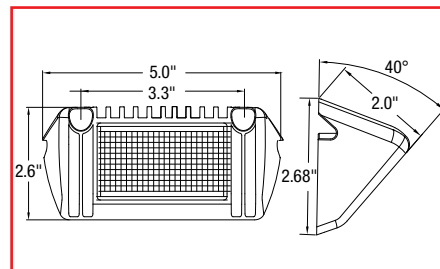
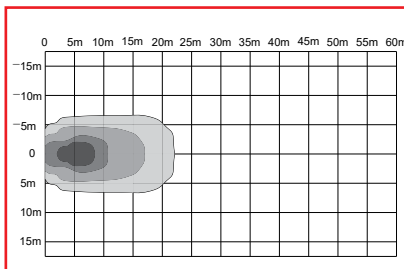

## 5" LED Switch and Handle

<b>5-YEAR</b> <b>W</b> <b>12-24</b> <b>VOLTS</b> <b>IP</b> <b>67</b>	<b>Number of LEDs</b>	9
	<b>Lumens</b>	1,710
	<b>Lead Length</b>	36"
	<b>Mount / Base</b>	SST Bracket

Part No.	Type	Color	Amp	Connection	Wt. (lbs.)	Cat.
 <b>1492193</b>	Flood	Clear	2.25	Blunt Cut	1.76	562 (N)

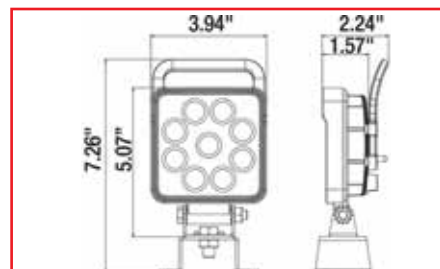
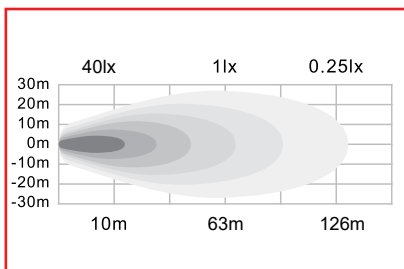

## 5" LED

<b>5-YEAR</b> <b>W</b> <b>12-24</b> <b>VOLTS</b> <b>IP</b> <b>67</b>	<b>Number of LEDs</b>	9
	<b>Lumens</b>	1,500
	<b>Lead Length</b>	36"
	<b>Mount / Base</b>	8mm Stud SST

Part No.	Type	Color	Amp	Connection	Wt. (lbs.)	Cat.
 <b>1492119</b>	Flood	Clear	2.25	Blunt Cut	1.76	562 (N)

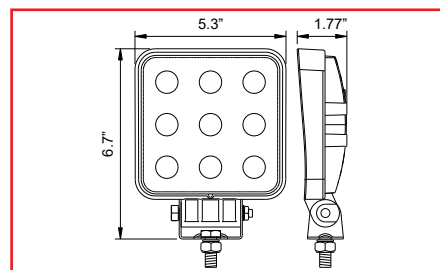
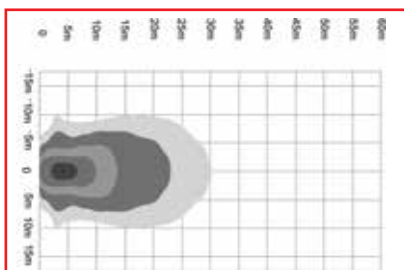

## 5.5" LED

5-YEAR  
**W**  
12  
**VOLTS**  
IP  
**67**

Number of LEDs	6
Lumens	1,620
Lead Length	36"
Mount / Base	8mm Stud SST



Part No.	Type	Color	Amp	Connection	Wt. (lbs.)	Cat.
1492135	Flood	Clear	1.5	Blunt Cut	1.6	562 (N)

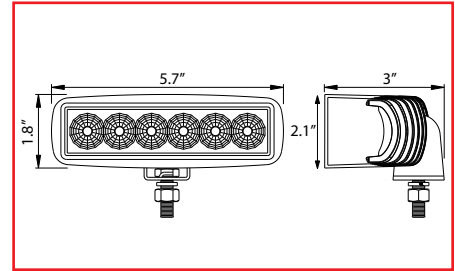
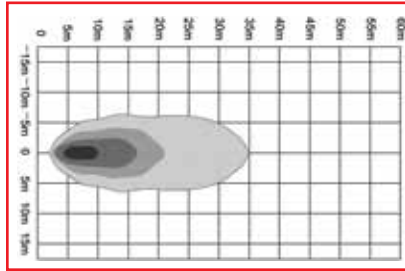

## 6" LED

5-YEAR  
**W**  
12-24  
**VOLTS**  
IP  
**67**

Number of LEDs	6
Lumens	1,350
Lead Length	36"
Mount / Base	10mm Stud SST



Part No.	Type	Color	Amp	Connection	Wt. (lbs.)	Cat.
1492118	Flood	Clear	1.5	Blunt Cut	1.75	562 (N)

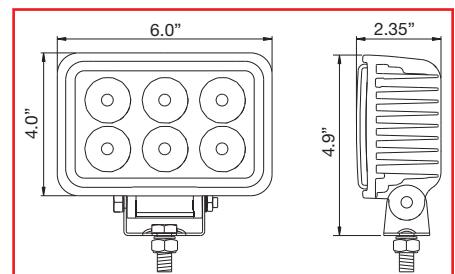
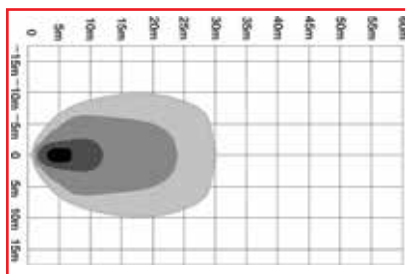

## Stainless Steel Mounts

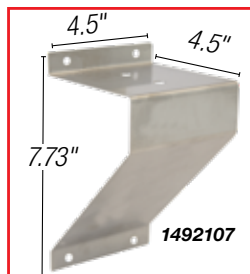
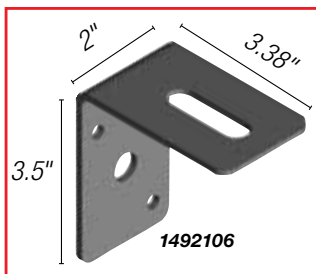

Part No.	Description	Wt. (lbs.)	Cat.
1492106	Stainless Steel Bracket	0.47	562 (N)
1492107	Stainless Steel Bracket	0.90	562 (N)



# Work Lights

## 4" LED

<b>5-YEAR</b> <b>W</b> <b>12-24</b> <b>VOLTS</b> <b>IP</b> <b>67</b>	Number of LEDs	1
	Lumens	483
	Lead Length	18"
	Mount / Base	SST

Part No.	Type	Color	Amp	Connection	Wt. (lbs.)	Cat.
 <b>1492221</b>	Fog	Clear	0.71	Blunt Cut	1.47	562 (N)

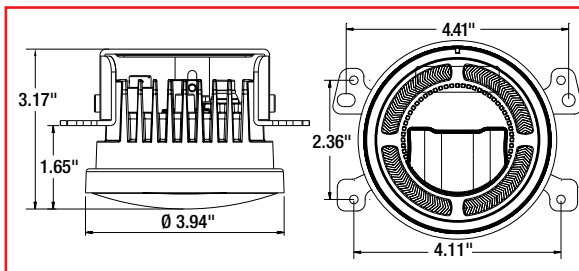

## Recessed 3" LED

<b>5-YEAR</b> <b>W</b> <b>12-24</b> <b>VOLTS</b> <b>IP</b> <b>67</b>	Number of LEDs	6
	Lumens	1,620
	Lead Length	18"
	Mount / Base	12mm Stud

Part No.	Type	Color	Amp	Connection	Wt. (lbs.)	Cat.
 <b>1492138</b>	Flood	Clear	1.38	Blunt Cut	1.37	562 (N)

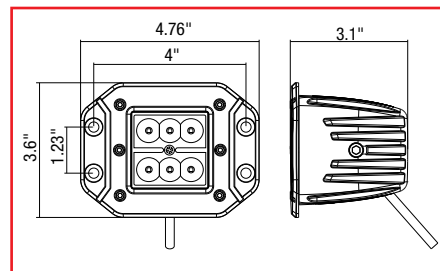
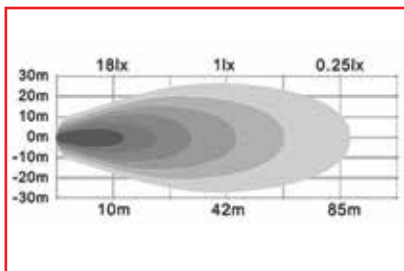

## Angle Mounted 3" LED

<b>5-YEAR</b> <b>W</b> <b>12-24</b> <b>VOLTS</b> <b>IP</b> <b>67</b>	Number of LEDs	3
	Lumens	1,260
	Lead Length	18"
	Mount / Base	Flat, Tubular and Angle

Part No.	Type	Color	Amp	Connection	Wt. (lbs.)	Cat.
 <b>1492139</b>	Flood	Clear	0.34	Blunt Cut	0.32	562 (N)

Mounting options included: flat, tubular and angle

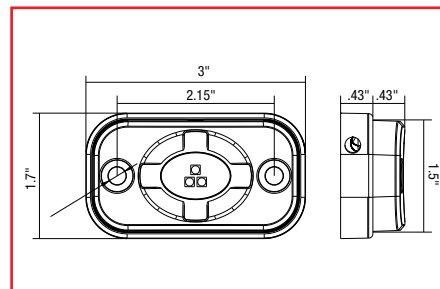
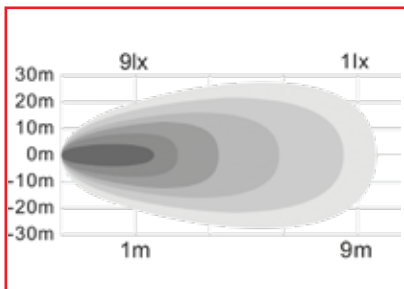

## Recessed 6.5" LED

5-YEAR  
**W**  
12-24  
**VOLTS**  
**IP**  
67

Number of LEDs	6
Lumens	1,140
Lead Length	18"
Mount / Base	Recessed, Diecast



Part No.	Type	Color	Amp	Connection	Wt. (lbs.)	Cat.
<b>1492191</b>	Flood	Clear	0.75	Blunt Cut	1.2	562 (N)

Includes 30° rubber offset mount



Side view of Rubber Mount

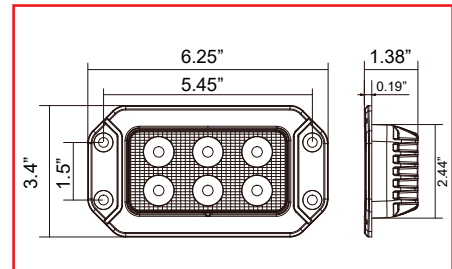
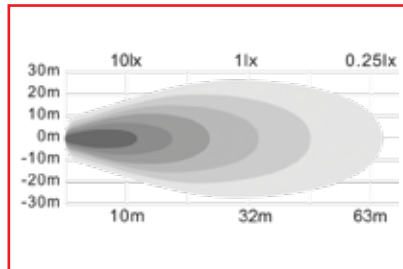

## 6" LED Scene Light

5-YEAR  
**W**  
12-24  
**VOLTS**  
**IP**  
67

Number of LEDs	52
Lumens	2,296
Lead Length	20"
Mount / Base	45° Angled



Part No.	Type	Color	Amp	Connection	Wt. (lbs.)	Cat.
<b>1492238*</b>	Flood	Clear	1.54	Blunt Cut	0.65	562 (N)

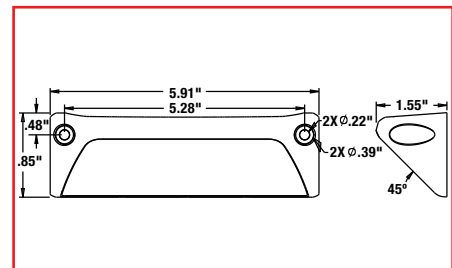
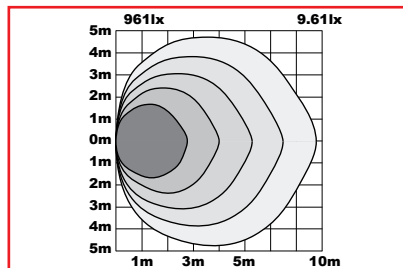

## Blue LED Pedestrian Warning Light for Forklifts

5-YEAR  
**W**  
12-24  
**VOLTS**

Number of LEDs	9
Lumens	400
Lead Length	16"
Mount / Base	10mm Stud SST



Part No.	Type	Color	Amp	Connection	Wt. (lbs.)	Cat.
<b>1492133*</b>	Spot	Clear	0.75	Blunt Cut	1.65	562 (N)

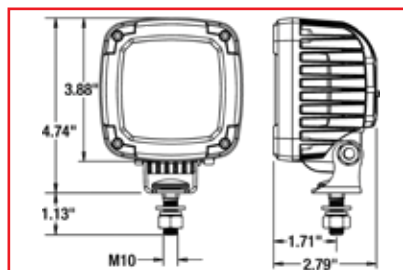

# Work Lights

## Edgeless Ultra Bright Dual Row LED Combination Light Bars *Featured on Cover*

5-YEAR  
**W**  
12-24  
**VOLTS**  
**IP**  
**67**  
**IP**  
**69K**

Color	Clear
Mount / Base	Aluminum

Part No.	LEDs	Type	Amp	Lead Length	Connection	Lumens	Wt. (lbs.)	Cat.
<b>1492260*</b>	12	Flood/Spot	3.78	19.5"	Deutsch	5,040	3.11	562 (N)
<b>1492261*</b>	24	Flood/Spot	7.73	19.5"	Deutsch	10,080	4.65	562 (N)
<b>1492262*</b>	40	Flood/Spot	14.60	39.25"	Deutsch	16,800	6.61	562 (N)
<b>1492263*</b>	60	Flood/Spot	20.80	39.25"	ATP	25,200	8.53	562 (N)
<b>1492265*</b>	96	Flood/Spot	30.60	96"	Blunt Cut	40,320	12.26	562 (N)

See pg. 27 for optional mounting brackets.

8"



1492260

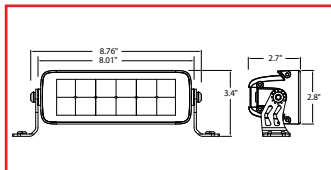
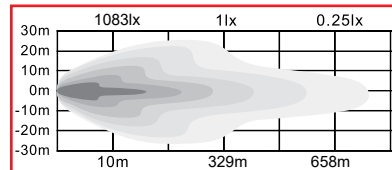

1492260 shown

14"



1492261

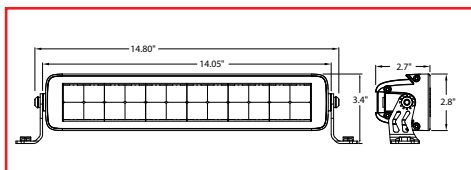
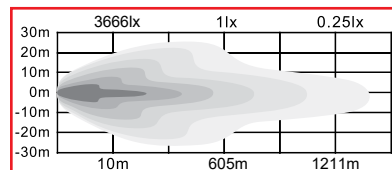

22"



1492262

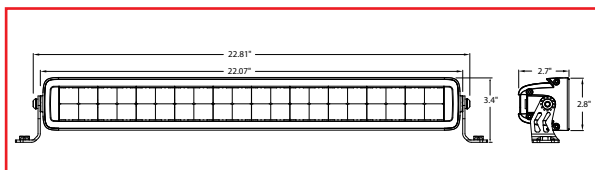
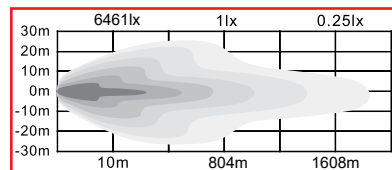

32"



1492263

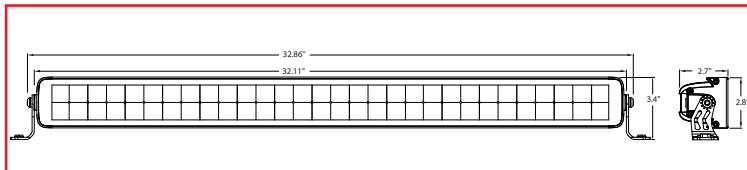
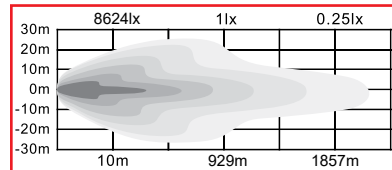

50"



1492265

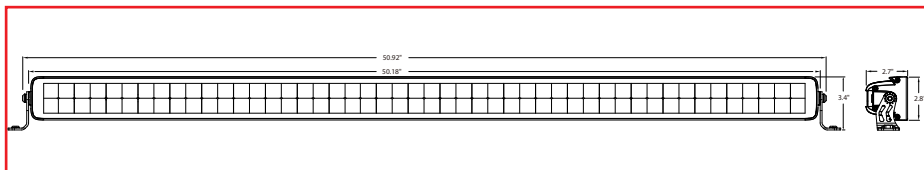
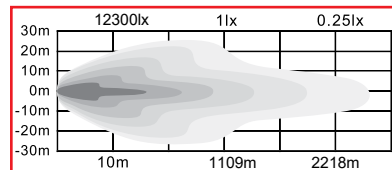



## Edgeless Ultra Bright Single Row LED Combination Light Bars

5-YEAR  
**W**  
12-24  
**VOLTS**  
**IP**  
**67**  
**IP**  
**69K**

Color	Clear
Mount / Base	Aluminum

Part No.	LEDs	Type	Amp	Lead Length	Connection	Lumens	Wt. (lbs.)	Cat.
<b>1492281*</b>	9	Flood/Spot	3.32	19.5"	Deutsch	3,780	3.84	562 (N)
<b>1492282*</b>	15	Flood/Spot	5.40	19.5"	Deutsch	6,300	4.37	562 (N)
<b>1492283*</b>	24	Flood/Spot	8.90	19.5"	Deutsch	10,008	6.06	562 (N)
<b>1492284*</b>	30	Flood/Spot	10.90	19.5"	ATP	12,600	7.70	562 (N)
<b>1492285*</b>	39	Flood/Spot	13.60	19.5"	ATP	16,380	10.00	562 (N)

See pg. 27 for optional mounting brackets.

13"



1492281

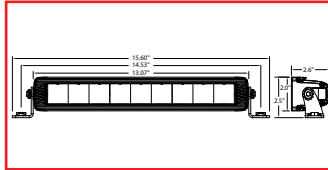
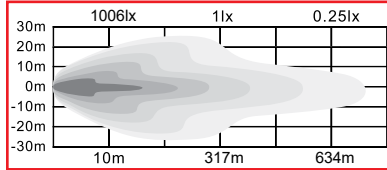

20"



1492282

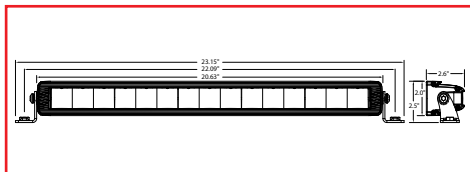
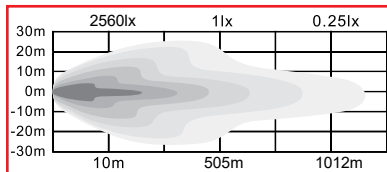

30"



1492283

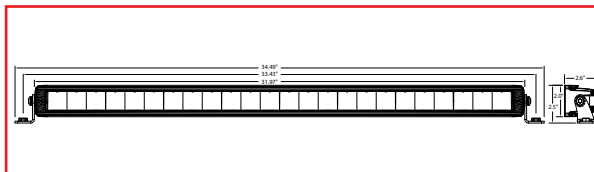
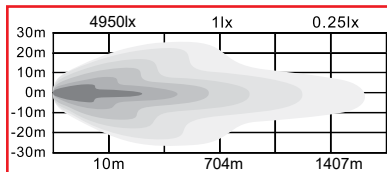

40"



1492284

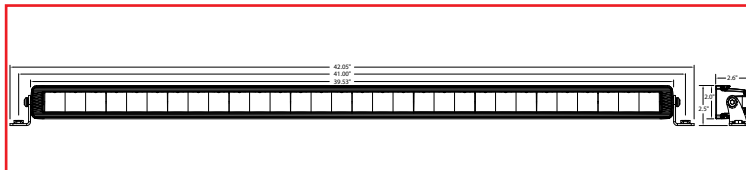
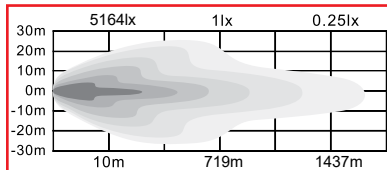

50"



1492285

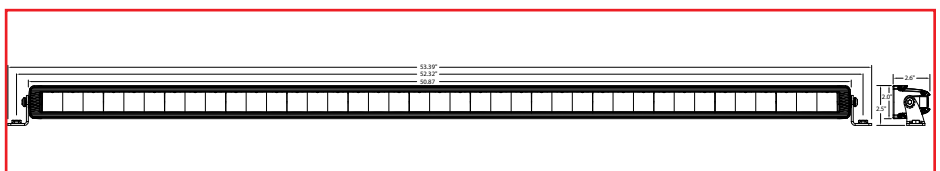
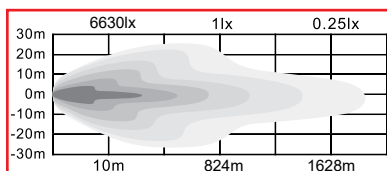

# Work Lights

## Ultra Bright Dual Row LED Combination Light Bars

<b>5-YEAR W 12-24 VOLTS IP 67</b>	<b>Color</b>	Clear
	<b>Connection</b>	Blunt Cut
	<b>Mount / Base</b>	Aluminum

Part No.	LEDs	Type	Amp	Lead Length	Lumens	Wt. (lbs.)	Cat.
<b>1492160</b>	12	Flood/Spot	2.0	33.5"	3,240	3.34	562 (N)
<b>1492161</b>	24	Flood/Spot	4.2	33.5"	6,480	4.98	562 (N)
<b>1492162</b>	40	Flood/Spot	8.2	52.5"	10,800	7.34	562 (N)
<b>1492163</b>	60	Flood/Spot	12.0	52.5"	16,200	10.15	562 (N)
<b>1492165</b>	96	Flood/Spot	16.0	52.5"	25,920	15.42	562 (N)

See pg. 27 for optional mounting brackets.

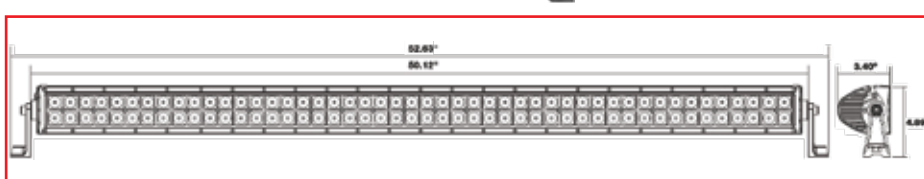
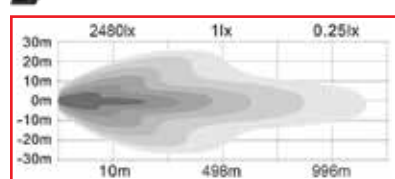
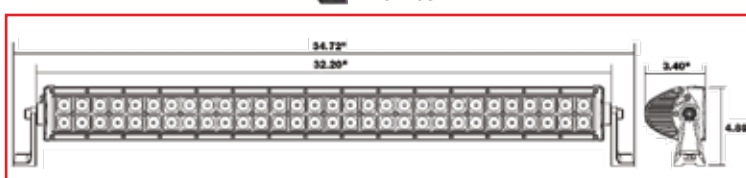
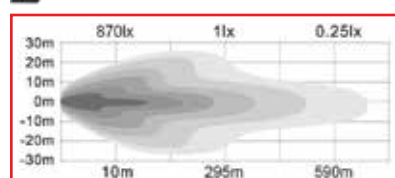
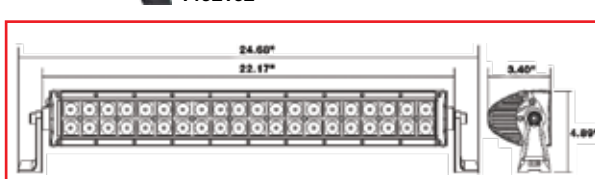
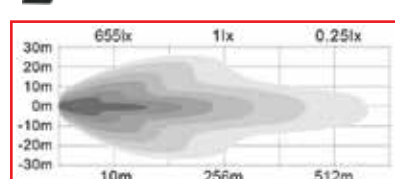
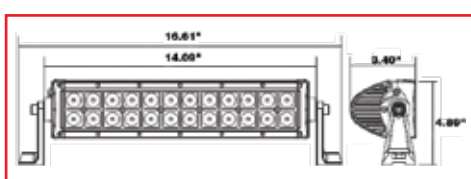
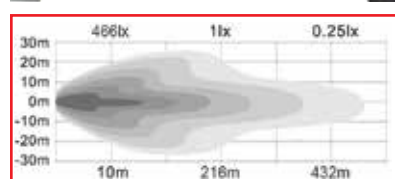
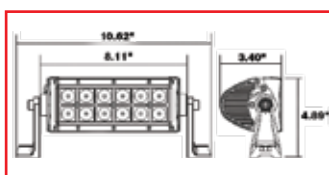
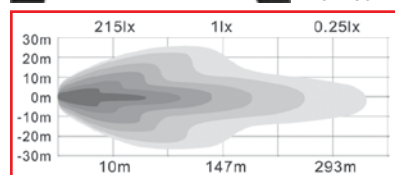

## Straight Single Row LED Combination Light Bars



Color	Clear
Connection	Blunt Cut
Mount / Base	Aluminum

Part No.	LEDs	Type	Amp	Lead Length	Lumens	Wt. (lbs.)	Cat.
1492182	15	Flood/Spot	2.80	30.5"	4,050	3.70	562 (N)
1492183	24	Flood/Spot	4.55	30.5"	6,480	5.45	562 (N)
1492184	30	Flood/Spot	5.78	30.5"	8,100	6.62	562 (N)
1492185	39	Flood/Spot	7.60	30.5"	10,530	8.80	562 (N)

Adjustable width mounts.  
See pg. 27 for optional mounting brackets.

20.5"



1492182

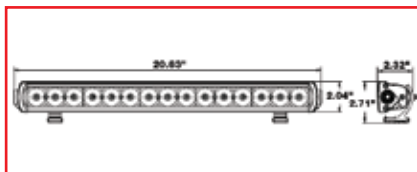
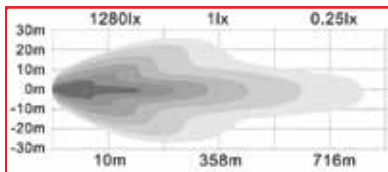

32"



1492183

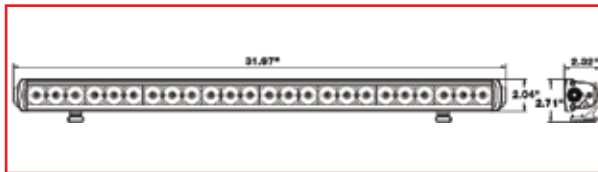
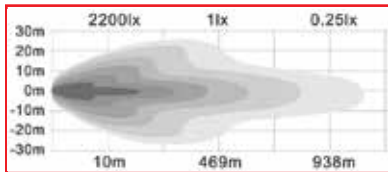

39.5"



1492184

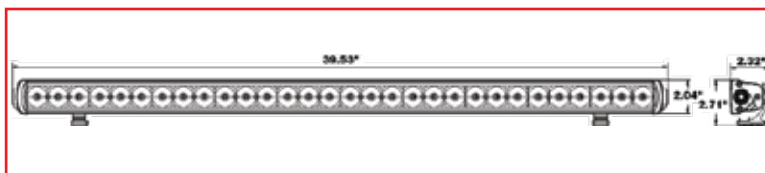
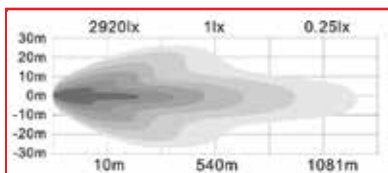

51"



1492185

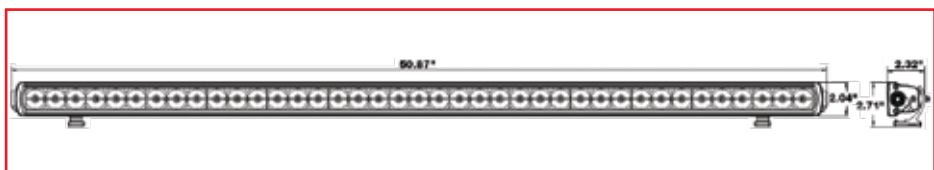
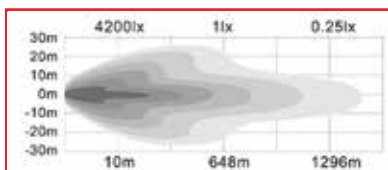



# Work Lights

## Ultra Bright Dual Row LED Curved Combination Light Bars

<b>5-YEAR</b> <b>W</b> <b>12-24</b> <b>VOLTS</b> <b>IP</b> <b>67</b>	<b>Color</b>	Clear
	<b>Connection</b>	Blunt Cut
	<b>Mount / Base</b>	Aluminum

Part No.	LEDs	Type	Amp	Lead Length	Lumens	Wt. (lbs.)	Cat.
<b>1492171</b>	24	Flood/Spot	4.2	33.5"	6,480	4.93	562 (N)
<b>1492172</b>	40	Flood/Spot	8.2	52.5"	10,800	7.29	562 (N)

See pg. 27 for optional mounting brackets.

14"

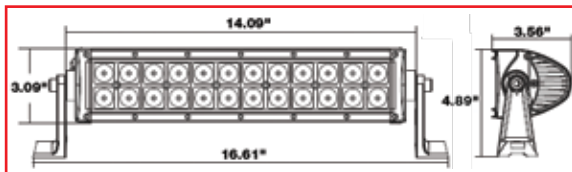
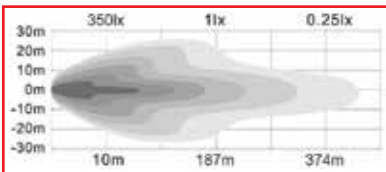

22"

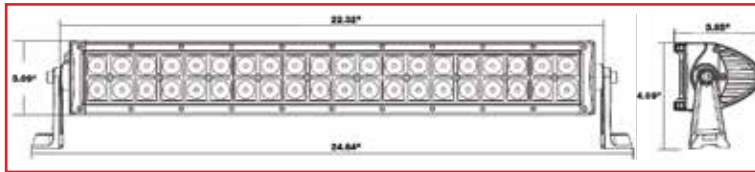
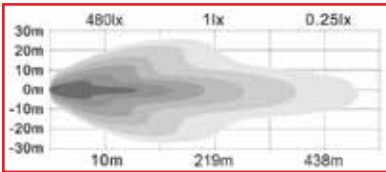

1492172 shown



## Rear Mounting Legs, 1492260 Series



Part No.	Description	Wt. (lbs.)	Cat.
3048967	Rear Mount Mounting Legs, Pair, For use with 1492260 Series	??	562 (N)

## Rear Mounting Legs, 1492280 Series



Part No.	Description	Wt. (lbs.)	Cat.
3048966	Rear Mount Mounting Legs, Pair, For use with 1492280 Series	??	562 (N)

## Rear Mounting Legs, 1492160 and 1492170 Series



Part No.	Description	Wt. (lbs.)	Cat.
3034110	Rear Mount Mounting Legs, Pair, For use with 1492160 and 1492170 Series	0.66	562 (N)

## Tube Mount, 1492160 and 1492180 Series



Part No.	Description	Wt. (lbs.)	Cat.
3035781	Tube Mount, Pair, For use with 1492160 and 1492180 Series	1.44	562 (N)

## Tube X Mount, 1492160 and 1492180 Series



Part No.	Description	Wt. (lbs.)	Cat.
3035783	Tube X Mount, Pair, For use with 1492160 and 1492180 Series	1.76	562 (N)

## Harness with Single Switch



3035768



3035770

Part No.	Description	Wt. (lbs.)	Cat.
3035768	Harness with Single Switch, DT Connection	0.93	562 (N)
3035770	Harness with Single Switch, ATP Connection	1.04	562 (N)

For 1492160, 1492170, 1492180 series work lights.

# Work Lights

## Silicone LED Strip Lights With 3M™ Adhesive Back

LIMITED  
LIFETIME  
**W**  
12  
VOLTS  
IP  
68

Connection	Blunt Cut, Both Ends
Hardware Included	End Caps and Mounting Clips

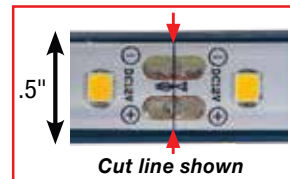

### Clear Warm Strip Lights

Part No.	Color	Size	LED's	Amps	Lumens	Wt. (lbs.)	Cat.
5622029*	Clear, Warm	18"	27	0.45	486	0.31	562 (N)
5622840*	Clear, Warm	24"	36	0.60	648	0.35	562 (N)
5623856*	Clear, Warm	36"	54	0.90	972	0.40	562 (N)
5625276*	Clear, Warm	48"	72	1.20	1,296	0.44	562 (N)



### Clear Cool Strip Lights

Part No.	Color	Size	LED's	Amps	Lumens	Wt. (lbs.)	Cat.
5622120*	Clear, Cool	18"	27	0.45	513	0.31	562 (N)
5622941*	Clear, Cool	24"	36	0.60	684	0.35	562 (N)
5623957*	Clear, Cool	36"	54	0.90	1,026	0.40	562 (N)
5625377*	Clear, Cool	48"	72	1.20	1,368	0.44	562 (N)





## LED Strip Lights With 3M™ Adhesive Back



Connection	Blunt Cut, Both Ends
Hardware Included	End Caps and Mounting Clips

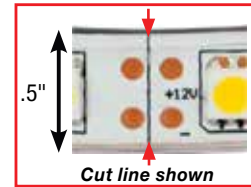

### Clear Warm Strip Lights

Part No.	Color	Size	LED's	Amps	Lumens	Wt. (lbs.)	Cat.
5621827	Clear, Warm	18"	27	0.41	360	0.31	562 (N)
5622436	Clear, Warm	24"	36	0.54	470	0.35	562 (N)
5623654	Clear, Warm	36"	54	0.81	710	0.40	562 (N)
5624872	Clear, Warm	48"	72	1.12	940	0.44	562 (N)
5626090	Clear, Warm	60"	90	1.30	1,180	0.55	562 (N)
56296144	Clear, Warm	96"	144	2.00	2,160	0.88	562 (N)



### Clear Cool Strip Lights

Part No.	Color	Size	LED's	Amps	Lumens	Wt. (lbs.)	Cat.
5621928	Clear, Cool	18"	27	0.41	360	0.31	562 (N)
5622537	Clear, Cool	24"	36	0.54	470	0.35	562 (N)
5623755	Clear, Cool	36"	54	0.81	710	0.40	562 (N)
5624973	Clear, Cool	48"	72	1.12	940	0.44	562 (N)
5626191	Clear, Cool	60"	90	1.30	1,175	0.55	562 (N)
56297145	Clear, Cool	96"	144	2.00	2,160	0.88	562 (N)
562109166	Clear, Cool	108"	165	3.00	2,400	1.12	562 (N)
562133202	Clear, Cool	132"	201	4.00	3,000	1.37	562 (N)



### Red Strip Lights

Part No.	Color	Size	LED's	Amps	Lumens	Wt. (lbs.)	Cat.
5622638	Red	24"	36	0.54	470	0.35	562 (N)
5625074	Red	48"	72	1.12	940	0.44	562 (N)



### Blue Strip Lights

Part No.	Color	Size	LED's	Amps	Lumens	Wt. (lbs.)	Cat.
5622739	Blue	24"	36	0.54	470	0.35	562 (N)
5625175	Blue	48"	72	1.12	940	0.44	562 (N)



### Accessories

Part No.	Description	Wt. (lbs.)	Cat.
3035896	LED Strip Light Mounting Channel, 17-1/2" Long, Black, Mounting 3M® Tape	0.39	562 (N)



### Accessories

Part No.	Description	Wt. (lbs.)	Cat.
5621002	LED Strobe Controller with 6" Leads, Converts Steady-On Strip Lights to a Strobe Pattern	0.07	562 (N)



# Work Lights

## 5" Round LED Interior Dome Lights



Number of LEDs	36
Lumens	2,200
Lead Length	8"
Connection	Blunt Cut

Part No.	ON/OFF Function	Color	Amp	Mounting	Wt. (lbs.)	Cat.
5625336	Remote Switch	Clear	1.5	Surface	0.39	562 (N)
5625337	Built-In Switch	Clear	1.5	Surface	0.39	562 (N)
5625338	Motion Sensor	Clear	1.5	Surface	0.39	562 (N)
5627036	Built-In Switch	Clear	1.5	Recessed	0.39	562 (N)
5627038	Motion Sensor	Clear	1.5	Recessed	0.39	562 (N)



## Oval LED Interior Dome Lights



Number of LEDs	10
Lumens	80
Mounting	Grommet

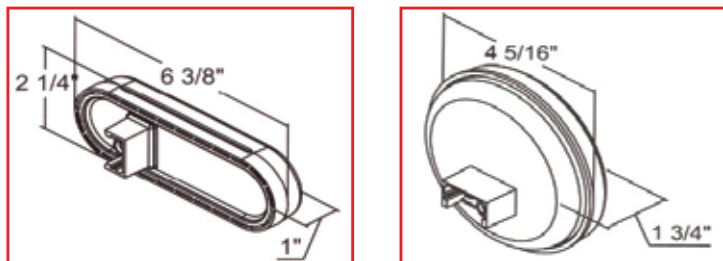

Part No.	Color	Amp	Connection	Std. Qty.	Wt. (lbs.)	Cat.
5626352	Clear	0.221	PL-3 Connection	10	0.37	562 (N)
5624352	Clear	0.221	PL-3 Connection	10	0.34	562 (N)



### Accessories

Part No.	Description	Std. Qty.	Wt. (lbs.)	Cat.
5624050	Black Grommet for use with 5626352	10	0.15	562 (N)
5626050	Black Grommet for use with 5624352	10	0.15	562 (N)
5620350	3-Pin Right Angle Male Plug with Stripped Power Leads and #10 Ring on Ground	25	0.03	562 (N)

**Bulk.** Part number indicates single item only. 5626050 must be ordered in multiples of 10, and 5620350 must be ordered in multiples of 25.



## 4.4" LED Projector Light

5-YEAR  
**W**  
12  
**VOLTS**  
**IP**  
67

Number of LEDs	3
Lumens	120
Lead Length	36"
Base / Mount	Aluminum/SS Bracket

Part No.	Color	Amp	Connection	Wt. (lbs.)	Cat.
 5624433	Clear	0.30	Blunt Cut	0.37	562 (N)

Ideal for cab steps and perimeter ground lighting

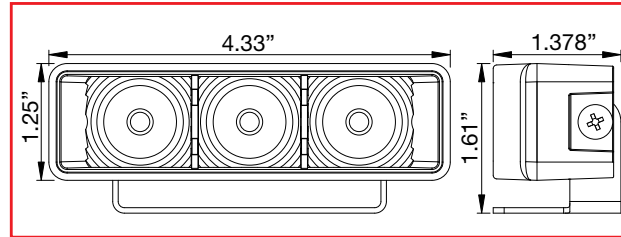

## LED Rope Light with Connections and Mounts

5-YEAR  
**W**  
12  
**VOLTS**  
**IP**  
67

Number of LEDs	576
Lumens	48-60 per Foot
Size	52.5'
Base / Mount	Clips

Part No.	Color	Amp	Connection	Wt. (lbs.)	Cat.
 5625576	Clear	3.8	Plug	6	562 (N)

Ideal for lighting truck compartments or truck boxes

Includes mounting hardware and connections  
Can be cut every 3 LEDs



End Cap

Clip

Power Cable







**PLOW**



# LIGHTS



# LED Plow Lights

## Low Profile Heated LED Plow Light Kit

12-24 VOLTS  
IP 68

Number of LEDs	15 Clear LEDs
Color Temperature	5200K - 5700K
Connection	19" 6 Pin Deutsch Connector
Mount	Dual Post Mount
Housing	Black Powder-Coated Aluminum

Part No.	Lumens	Amp	Wt. (lbs.)	Cat.
 <b>1312100*</b>	High Beam 3600 lm Low Beam 1800 lm	4.0	12	900 (N)

Heated tempered glass lens helps prevent ice from building up.  
Over twice as bright as traditional halogens, with a much longer lifespan.  
12V relay may be required (not included) for heated function on certain trucks.

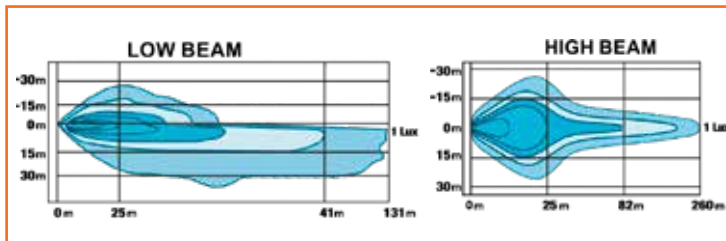
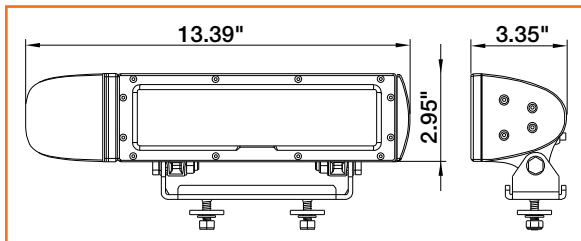

## Universal Heated LED Snow Plow Headlights

12-24 VOLTS  
IP 65

Number of LEDs	13 Clear LEDs
Color Temperature	5300K - 6000K
Connection	11" 6 Pin Deutsch Connector
Mount	Single Post Mount
Housing	Black Powder-Coated Aluminum

Part No.	Lumens	Amp	Wt. (lbs.)	Cat.
 <b>1312000*</b>	High Beam 2,500 lm Low Beam 1,200 lm	5.5	9.8	900 (N)

Heated tempered glass lens helps prevent ice from building up.  
Over twice as bright as traditional halogens, with a much longer lifespan.  
12V relay may be required (not included) for heated function on certain trucks.

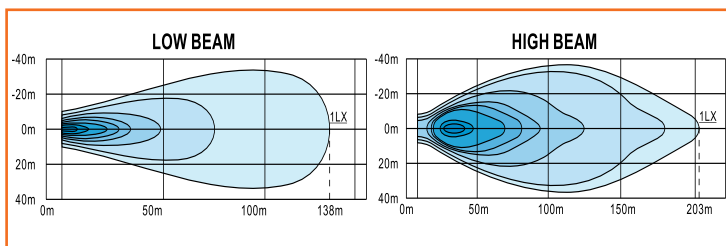
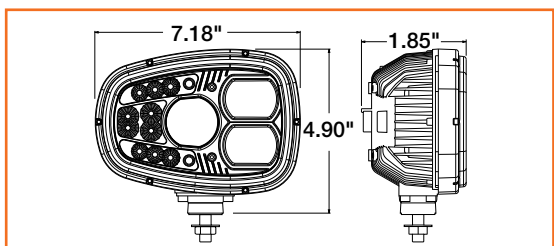



## Square Heated LED Plow Light with Multi-Directional Mount for Indicator

12-24  
VOLTS  
IP  
68  
IP  
69K

Number of LEDs	11 Clear LEDs
Color Temperature	5700K
Connection	16" 6 Pin Deutsch Connector
Mount	Multi-Mount
Housing	Black Powder-Coated Aluminum

Part No.	Lumens	Amp	Wt. (lbs.)	Cat.
 1312200*	High Beam 3600 lm Low Beam 1800 lm	5.7	9.5	900 (N)

Heated tempered glass lens helps prevent ice from building up. Over twice as bright as traditional halogens, with a much longer lifespan. 12V relay may be required (not included) for heated function on certain trucks.

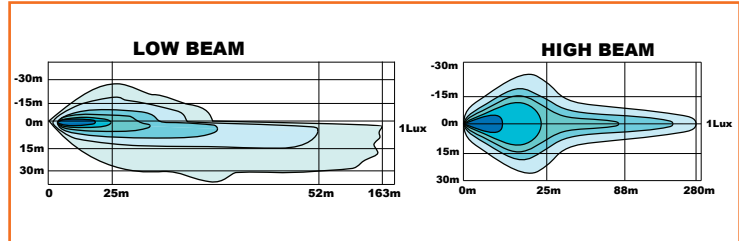
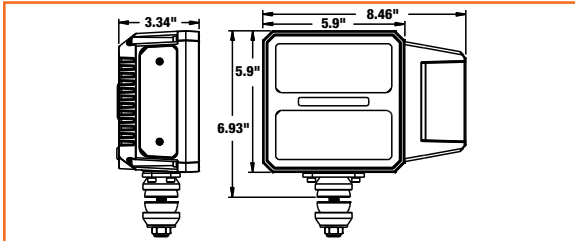

## Universal Snowplow Light Kit

1-YEAR  
W  
12  
VOLTS



- High-impact polycarbonate case
- Double-post mounts
- Includes universal wiring harness

Part No.	Description	Amp	Wt. (lbs.)	Cat.
1311100	Dual Beam Halogen Headlamps with Turn Signal/Parking Light	24.0	10.45	900 (N)



### Accessories

Part No.	Description	Wt. (lbs.)	Cat.
1311110	Headlight Adapter for International® Trucks	1.09	900 (N)
3014194	Low Beam Replacement Bulb for 1311100	???	900 (N)
3014193	Hi Beam Replacement Bulb for 1311100	???	900 (N)
1311103	Amber Park/Turn Replacement Bulb for 1311100	???	900 (N)

## Stainless Steel Truck Hood Light Brackets

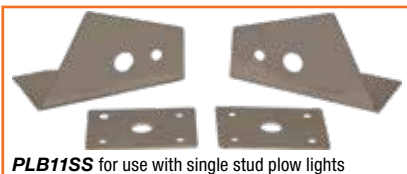

Part No.	Description	Style	Wt. (lbs.)	Cat.
PLB11SS	Stainless Steel Truck Hood Light Brackets with Hardware	Single Stud	5.0	900 (N)
PLB12SS	Extended Stainless Steel Truck Hood Light Brackets with Hardware	Dual Stud	5.0	900 (N)

Kit includes driver & passenger side bracket, gaskets & fasteners.

Universal fit for med./hvy. class truck hoods:

Ford®, Freightliner®, GMC®, International®, Mack®, Peterbilt®, Sterling®, Volvo®



# WARNING



# G LIGHTS



# LED Modular Light Bars

## LED Modular Light Bar Series



- Standard with amber strobes
- Customize by adding amber, blue, green, clear and/or red strobes
- Middle strobes have 3-LED reflector heads
- Corner strobes have 6-LED D-fuser heads
- Dimming mode
- Extruded aluminum frame

- 13" wide x 2" tall
- Optional work lights and take down lights on 49", 54" & 60" models
- Mounting feet and controller sold separately (see pg C16)
- Available in 24", 49", and 60" sizes
  - 54" models available - call for quotes

### 24" LED Modular Light Bar



### 49" LED Modular Light Bar



### 60" LED Modular Light Bar



8893060 shown with mounting feet  
(Mounting feet and controller sold separately)

Part No.	Size	LEDs	Amp	Modules	Description	Chassis Diagram	Wt. (lbs.)	Cat.
8893024	24"	36	3-6	8	Amber		15.4	889 (N)
88930243	24"	36	3-6	4	Amber, 4 Clear		15.4	889 (N)
8893049	49"	54	7-14	14	Amber Built-in Traffic Advisor		33.0	889 (N)
88930492	49"	36	7-14	8	Amber		31.8	889 (N)
88930493	49"	36	7-14	4	Amber, 4 Clear		31.8	889 (N)
8893060	60"	60	8-16	14	Amber, 2 Red Stop-Turn-Tail Lights Built-in Traffic Advisor		36.1	889 (N)
88930603	60"	42	8-16	8	Amber, 2 Red Stop-Turn-Tail Lights 2 Take Down Lights		34.7	889 (N)
88930604	60"	48	8-16	12	Amber		34.9	889 (N)
88930605	60"	60	8-16	16	Amber Built-in Traffic Advisor		36.1	889 (N)

Amber Strobe
  Clear Strobe
  Red Strobe  
 Stop-Turn-Tail Lights
  Clear Take  
 Down Lights



## Buyers Custom Light Bars

### Customizing Stock Light Bars

Modular light bars can be customized by purchasing the accessory light heads listed below. This allows light heads to be added or colors to be changed without having to buy a new light bar. Takedown and alley lights can also be added to 49", 54" and 60" models (not 24").

### Custom Light Bar Program

Factory built custom modular light bars are also available in 24", 49", 54" and 60" lengths. Customers choose their light head configuration and colors. Buyers Products will then quote, build, test, and ship the custom light bar. Call or email customer service at (440) 974-8888, [customer care@buyersproducts.com](mailto:customer care@buyersproducts.com) or visit [buyersproducts.com](http://buyersproducts.com) for more information.

### LED Middle Strobe



Part No.	LEDs	Color	Wt. (lbs.)	Cat.
3024631	3	Amber	0.28	889 (N)
3024632	3	Clear	0.27	889 (N)
3024633	3	Red	0.28	889 (N)
3024634	3	Blue	0.27	889 (N)
3032932*	3	Green	0.28	889 (N)

\*3032932 is not CA13 or SAE J595 Class 1

### LED Corner Strobe



Part No.	LEDs	Color	Wt. (lbs.)	Cat.
3024635	6	Amber	0.21	889 (N)
3024636	6	Clear	0.20	889 (N)
3024637	6	Red	0.21	889 (N)
3024638	6	Blue	0.21	889 (N)
3032933*	6	Green	0.21	889 (N)

\*3032933 is not CA13 or SAE J595 Class 1

### LED Middle Take Down Light Head



Part No.	LEDs	Color	Wt. (lbs.)	Cat.
3024639	6	Clear	0.23	889 (N)
3024640	9	Clear	0.23	889 (N)

### LED Alley Lights



Part No.	LEDs	Color	Wt. (lbs.)	Cat.
3024642	3	Clear	0.14	889 (N)

# LED Modular Light Bar Accessories

## Plastic Mounting Feet for LED Modular Light Bar



3024646 shown with 24" light bar

Part No.	Size	Wt. (lbs.)	Cat.
3024646	12.625"L x 5.50"W x 2.25"T	2.58	889 (N)

Feet have an adjustable width.  
Used in conjunction with stainless steel strap kits.

## Steel Mounting Feet for LED Modular Light Bar



3024647 shown with 24" light bar

Part No.	Size	Wt. (lbs.)	Cat.
3024647	10.125"L x 6.5"W x 2-3"T	3.89	889 (N)

Feet have an adjustable height and are black powder-coated.  
Used in conjunction with stainless steel strap kits.

## Headache Rack Steel Mounting Feet for LED Modular Light Bars



3024648 shown with 24" light bar

Part No.	Size	Wt. (lbs.)	Cat.
3024648	4.5"L x 6.75"W x 1.75"T	3.16	889 (N)

Black powder-coat finish.  
Designed with a narrow surface for tight spaces.

## Wide-Surface Steel Mounting Feet for LED Modular Light Bars



3024649 shown with 24" light bar

Part No.	Size	Wt. (lbs.)	Cat.
3024649	8.75"L x 2.50"W x 2.25"T	2.47	889 (N)

Black powder-coat finish.  
Designed for use on flat surfaces or cab roofs.

## Stainless Steel Strap Kits for LED Modular Light Bars

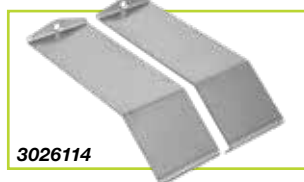

3026114



3025442



3026116

### Ford Trucks

Part No.	Make/Model	Wt. (lbs.)	Cat.
3026114	F-150 (2004-2014), Light Bars: 49", 54" & 60"	1.60	889 (N)
3034400	F-150 (2015+) F250/F550 (2017+), Light Bars: 49", 54" & 60"	1.60	889 (N)
3026115	F-250/350/450/550 (1999-2016), Light Bars: 49", 54" & 60"	1.60	889 (N)

### GM/Chevy Trucks

Part No.	Make/Model	Wt. (lbs.)	Cat.
3025442	GM1500/2500/3500/4500/5500 (Up to 2018), Light Bars: 49", 54" and 60"	1.53	889 (N)
3042509	GM1500/2500/3500 (2019+), Light Bars: 49", 54" and 60"	1.53	889 (N)

### Dodge/RAM Trucks

Part No.	Make/Model	Wt. (lbs.)	Cat.
3026116	RAM 500/2500/3500/4500/5500, (2009-2018), Light Bars: 49", 54" and 60"	1.60	889 (N)



## 4 Switch Panel, Pre-Wired



Part No.	Description	Wt. (lbs.)	Cat.
6391204	4-Switch Panel, Pre-Wired, 3.75"L x 1.25"W x 1.5"T	0.27	639 (N)

Built-in traffic advisor controls.  
For use with 49", 54" & 60" modular light bars.

## 5 Switch Panel, Pre-Wired



Part No.	Description	Wt. (lbs.)	Cat.
6391205	5-Switch Panel, Pre-Wired, 3.5"L x 1.0"W x 2.5"T	0.35	639 (N)

For use with 49", 54" & 60" modular light bars, plus surface and recessed mounted strobes.

## 6 Switch Panel, Pre-Wired with LED Pattern Display



Part No.	Description	Wt. (lbs.)	Cat.
6391206	6-Switch Panel, Pre-Wired with LED Pattern Display, 6.5"L x 0.75"W x 2.75"T	0.39	639 (N)

Built-in traffic advisor controls.  
For use with 49", 54" & 60" modular light bars.

## 7 Function Programmable Switch Panel



Part No.	Description	Wt. (lbs.)	Cat.
6391208	Switch Panel, 7 Function, Multi-Purpose, Programmable	0.83	639 (N)

The programmable panel supports up to 7 functions, and can be used to control multiple lights and/or other equipment.  
For use with 49", 54" & 60" modular light bars.

## 8 Function Programmable Switch Panel with Relays



Part No.	Description	Wt. (lbs.)	Cat.
6391209	Switch Panel, 8 Function, Multi-Purpose, Programmable with Relays	0.83	639 (N)

The programmable panel supports up to 7 functions, and can be used to control multiple lights and/or other equipment.  
The relay allows the switch panel to deliver additional amperage to lighting accessories with higher power demands.  
For use with 49", 54" & 60" modular light bars.



# LED Light Bars

## LED 48" Wireless Light Bar with Traffic Advisor *Featured on Cover*

<b>5-YEAR W 12-24 VOLTS</b>	Number of LEDs	136
	Number of Flash Patterns	13
<b>IP 67</b>	Lead Length	25'
	Housing	Aluminum
<b>SAE J949 CLASS 1</b>	Mount	Feet and Strap Kit Included

Light features a wireless hand held remote that displays the patterns being used.



**INCLUDES:** Wireless remote control. Screen indicates light bars functions.

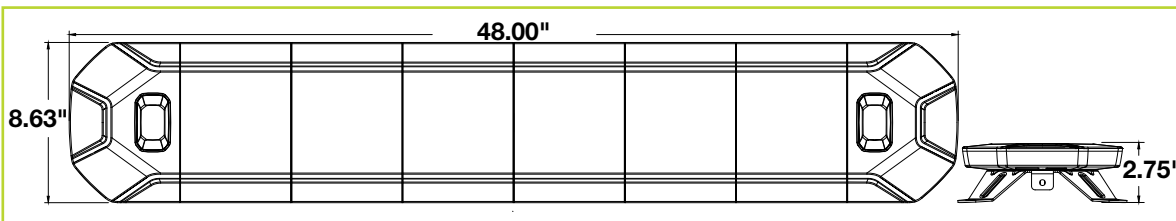

### Single Color

Part No.	Color	Amp	Wt. (lbs.)	Cat.
<b>8893048*</b>	Amber	11.30	20	889 (N)



### Dual Color

Part No.	Color	Amp	Wt. (lbs.)	Cat.
<b>8893148*</b>	Amber/Clear	11.30	20	889 (N)



8893048 shown

## 11" Rectangular Multi-Mount LED Mini Light Bar

**5-YEAR  
W  
12-24  
VOLTS**

Number of LEDs	24
Number of Flash Patterns	10
Lead Length	15' with ON/OFF and Pattern Switch
Mount	Permanent or Magnetic

See pg. 48-49 for Drill-Free Cab Mount Options

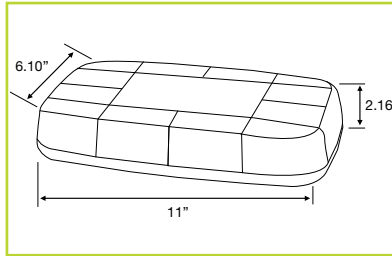

Part No.	Color	Amp	Wt. (lbs.)	Cat.
8891040	Amber	2.0	3.5	889 (N)



Part No.	Color	Amp	Wt. (lbs.)	Cat.
8891042	Amber/Clear	2.0	3.5	889 (N)



Part No.	Color	Amp	Wt. (lbs.)	Cat.
8891045	Amber/Blue	2.0	3.5	889 (N)



Part No.	Color	Amp	Wt. (lbs.)	Cat.
8891049	Amber/Green	2.0	3.5	889 (N)

## 11" Rectangular LED Mini Light Bar

**5-YEAR  
W  
12  
VOLTS**

Number of LEDs	24
Flash Patterns	1 (Random)
Lead Length	15' with ON/OFF
Mount	Magnetic

See pg. 48-49 for Drill-Free Cab Mount Options

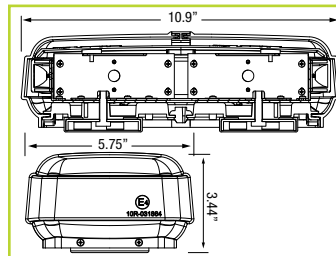

Part No.	Color	Amp	Wt. (lbs.)	Cat.
8891050	Amber	3.5	4.0	889 (N)



Part No.	Color	Amp	Wt. (lbs.)	Cat.
8891052	Amber/Clear	3.5	4.0	889 (N)

# LED Mini Light Bars

## 15" Octagonal LED Mini Light Bar Series

**5-YEAR  
W  
12-24  
VOLTS  
SAE J848  
CLASS  
1**

Number of LEDs	56
Number of Flash Patterns	10
Lead Length	15' with ON/OFF and Pattern Switch
Mount	Permanent or Magnetic

See pg. 48-49 for Drill-Free Cab Mount Options

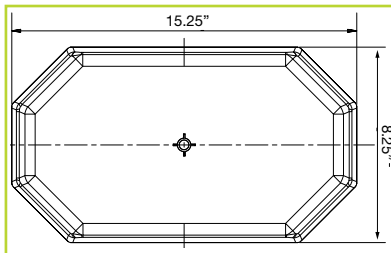

Permanent mounting studs and magnetic mounts



8891060

Part No.	Color	Amp	Wt. (lbs.)	Cat.
8891060	Amber	3.2	5.5	889 (N)



8891062

Part No.	Color	Amp	Wt. (lbs.)	Cat.
8891062	Amber/Clear	3.2	5.5	889 (N)



8891068

Part No.	Color	Amp	Wt. (lbs.)	Cat.
8891068*	Amber/Blue	3.2	5.5	889 (N)

## 10" Oval Low Profile LED Mini Light Bar

**5-YEAR  
W  
12-24  
VOLTS  
SAE J848  
CLASS  
1**

Number of LEDs	40
Flash Patterns	20
Lead Length	15' with ON/OFF and Pattern Switch
Mount	Permanent or Magnetic

See pg. 48-49 for Drill-Free Cab Mount Options

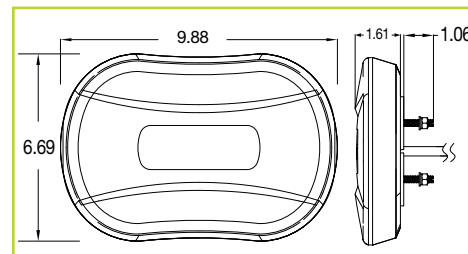

Permanent mounting studs and magnetic mounts



8891080

Part No.	Color	Amp	Wt. (lbs.)	Cat.
8891080	Amber	3.34	3.1	889 (N)



8891082

Part No.	Color	Amp	Wt. (lbs.)	Cat.
8891082	Amber/Clear	3.34	3.1	889 (N)





## 15" Hexagonal Low Profile Mini Light Bar

5-YEAR  
**W**  
12-24  
**VOLTS**  
SAE J848  
CLASS  
**1**

Number of LEDs	56
Number of Flash Patterns	10
Lead Length	15' with ON/OFF and Pattern Switch
Mount	Permanent or Magnetic

See pg. 48-49 for Drill-Free Cab Mount Options

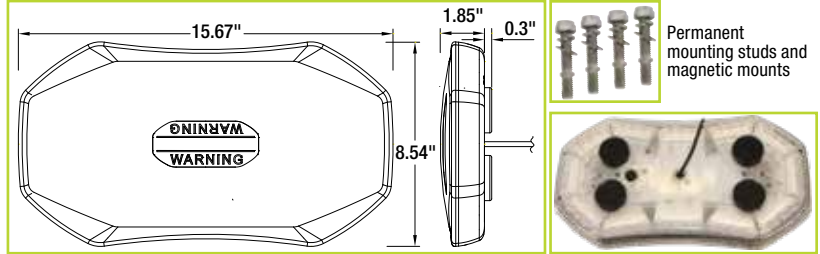

8891110

Part No.	Color	Amp	Wt. (lbs.)	Cat.
8891110	Amber	3.52	4.65	889 (N)



8891111

Part No.	Color	Amp	Wt. (lbs.)	Cat.
8891111	Amber/Clear	3.52	4.65	889 (N)

## 16.5" Rectangular LED Mini Light Bar

5-YEAR  
**W**  
12-24  
**VOLTS**  
SAE J848  
CLASS  
**1**

Number of LEDs	18
Flash Patterns	19
Lead Length	15' with ON/OFF and Pattern Switch
Mount	Vacuum or Magnetic

See pg. 48-49 for Drill-Free Cab Mount Options

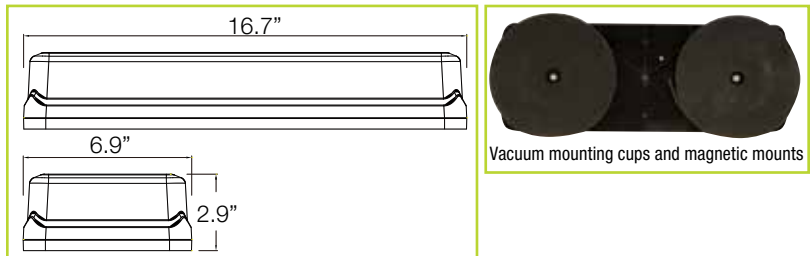

8891090

Part No.	Color	Amp	Wt. (lbs.)	Cat.
8891090	Amber	3.2	7.78	889 (N)



8891091

Permanent mounting studs and magnetic mounts

### Accessories

Part No.	Description	Wt. (lbs.)	Cat.
8891091	Aluminum Light Bar Mounting Bracket Kit	1.7	889 (N)

# LED Mini Light Bars and Dashboard Light Bars

## 17" Octagonal Mini Light Bar

**5-YEAR  
W  
12-24  
VOLTS**

Number of LEDs	30
Number of Flash Patterns	25
Lead Length	15' with ON/OFF and Pattern Switch
Mount	Magnetic

See pg. 48-49 for Drill-Free Cab Mount Options

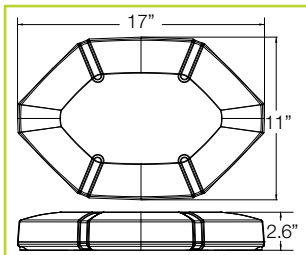

Permanent mounting studs and magnetic mounts



8891100

### Single Color SAE J845 Class 1 Light Bar

SAE J845  
CLASS  
1

Part No.	Color	Amp	Wt. (lbs.)	Cat.
8891100	Amber	3.6	9.9	889 (N)



8891102

### Dual Color Light Bar

Part No.	Color	Amp	Wt. (lbs.)	Cat.
8891102	Amber/Clear	3.6	9.9	889 (N)



**8891010**  
Includes mounting brackets with 4 bolts and washers

### Accessories

Part No.	Description	Wt. (lbs.)	Cat.
8891010	Aluminum Mounting Brackets for 8891100 and 8891102	0.7	889 (N)

## 14" LED Dashboard Light Bar

**12-24  
VOLTS**

Number of LEDs	12
Flash Patterns	19
Lead Length	15' with ON/OFF and Pattern Switch
Mount	Vacuum or Adhesive Hook with Velcro

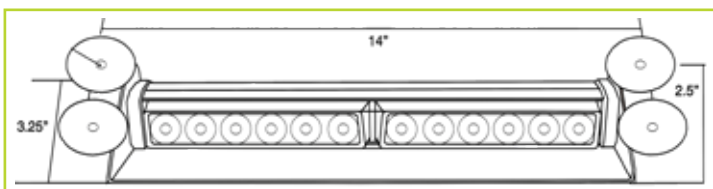

8891024

Part No.	Color	Amp	Wt. (lbs.)	Cat.
8891024	Amber	0.35	1.58	889 (N)



8891025

Part No.	Color	Amp	Wt. (lbs.)	Cat.
8891025	Amber/Clear	0.35	1.58	889 (N)



## 8" LED Dashboard Light Bar

**12-24 VOLTS**

Number of LEDs	8
Flash Patterns	19
Lead Length	9' with ON/OFF and Pattern Switch
Mount	Suction

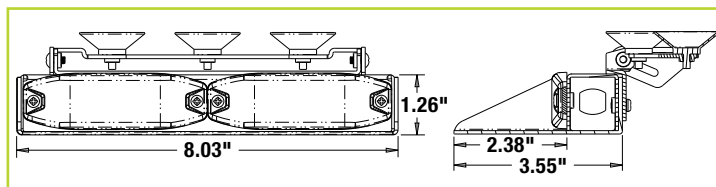

Part No.	Color	Amp	Wt. (lbs.)	Cat.
<b>8891023*</b>	Amber	2.0	1.1	889 (N)

Available Q4



Part No.	Color	Amp	Wt. (lbs.)	Cat.
<b>8891026*</b>	Amber/Clear	2.0	1.1	889 (N)

Available Q4



8891026 shown



# Drill-Free Light Bar Mounts and Cab Mounts

## Pro Series Drill-Free Light Bar Cab Mount

Construction	Rustproof Aluminum
Finish	Black Powder-Coated
Capacity	30 lbs.
Size	22" L x 10"W



8895560 shown with 8891060 light bar (sold separately)



8895560 shown with light bar 8891060 (not included)

### Ford Trucks

Part No.	Make/Model	Wt. (lbs.)	Cat.
8895560*	Ford F-150 (2015+), Ford F-250-550 (2017+) and Ranger SuperCrew (2019+)	13.2	889 (N)

Installs in third light OEM location, no drilling required.

## Drill-Free Light Bar Cab Mount

Construction	Rustproof Aluminum
Finish	Black Powder-Coated
Capacity	30 lbs.
Size	22" L x 10"W



8895152 shown with light bar 8891060 (not included)



8895115



8895301

### Ford Trucks

Part No.	Make/Model	Wt. (lbs.)	Cat.
8895152*	Ford F-150 (2015+), Ford F-250-550 (2017+) and Ranger (2019+) *Replaced 8895150*	7.25	889 (N)
8895250	Ford SuperDuty with Legacy Steel Cab F-250-550 (2006-2016)	7.25	889 (N)

Installs in third light OEM location, no drilling required.

### GM/Chevy Trucks

Part No.	Make/Model	Wt. (lbs.)	Cat.
8895115*	1500-4500 LT / LD with Spoiler (2020)	3.5	889 (N)
8895095	1500-3500 STD & XTD (2007-2013)	7.25	889 (N)
8895100	1500-3500 (2014-2018, All Models), 1500-3500 (2019 All Models) <b>Except 1500 LT &amp; LTZ</b>	7.25	889 (N)
8895105	For Chevy Colorado-GMC Canyon (2015-2017) with "I03" Antenna	7.25	889 (N)
8895120*	1500-3500 Chevy/GMC (2020)	7.25	889 (N)

Installs in third light OEM location, no drilling required.

### Dodge/RAM Trucks

Part No.	Make/Model	Wt. (lbs.)	Cat.
8895301*	1500 Classic / 2500-5500 All Models (2019+)	8.0	889 (N)
8895300	1500-4500 (2010-2018) <i>Only</i>	7.25	889 (N)
8895350	Dodge-Ram Cab & Chassis 5500 (2010-2018) <i>*Only for 5500*</i>	7.25	889 (N)

Installs in third light OEM location, no drilling required.



# Drill-Free Light Bar Mounts and Cab Mounts

## Fleet Series Drill-Free Light Bar Cab Mount

Construction	Rustproof Aluminum
Finish	Black Powder-Coated
Capacity	30 lbs.
Size	22" L x 10"W



8895551 shown with 8891060 light bar (sold separately)



8895556 shown with 8891042 light bar (sold separately)



8895551 shown with light bar 8891040 (not included)



8895554 shown with light bar 8891040 (not included)



8895556 shown with light bar 8891040 (not included)

### Ford Trucks

Part No.	Make/Model	Wt. (lbs.)	Cat.
8895551*	Ford F-150 (2015+) and Ford F-250/550 (2017+)	6.46	889 (N)

Installs in third light OEM location, no drilling required.

### GM/Chevy Trucks

Part No.	Make/Model	Wt. (lbs.)	Cat.
8895554*	1500-3500 Chevy/GMC Work Truck Cab (2020)	6.46	889 (N)

Installs in third light OEM location, no drilling required.

### Dodge/RAM Trucks

Part No.	Make/Model	Wt. (lbs.)	Cat.
8895556*	1500 Classic / 2500-5500 All Models (2019+)	6.46	889 (N)

Installs in third light OEM location, no drilling required.

## Self-Adhesive Magnetic Mount Pad for Aluminum Cabs

Construction	Carbon Steel
Finish	Black Powder-Coated
Size	3.5" L x 3.5"W
Mount	3M® Tape

Allows use of magnetic light mounts even on aluminum truck cabs

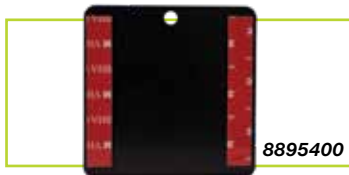

8895400 shown with SL695A beacon

Note: Allows use of magnetic light mounts even on aluminum truck cabs

Part No.	Description	Wt. (lbs.)	Cat.
8895400	Self-Adhesive Magnetic Mount Pad for Aluminum Cabs, Single	0.27	889 (N)
8895404	Self-Adhesive Magnetic Mount Pad for Aluminum Cabs, 4 pack	1.02	889 (N)

# Traffic Advisors

## LED Traffic Advisor / Strobe with Flood Light

<b>5-YEAR W</b> <b>12-24 VOLTS</b> <b>IP 67</b> <b>CA 13</b> <b>SAE J599 CLASS 1</b>	Number of Flash Patterns	50 Strobe 16 Traffic Arrows 1 Flood
	Color	Amber or Clear for Strobe and Traffic Arrows Clear for Flood
	Lead Length	25'
	Housing	Aluminum
	Mount	Rear Angle Mounts Included

Combines an SAE J595 Class 1 strobe, traffic advisor with 16 different arrows, and a bright flood light into a single versatile fixture.



Part No.	LEDs	A	B	C	Amp	Wt. (lbs.)	Cat.
<b>8894134*</b>	96 LEDs	33.7"	2.1"	1.25"	3.0	5.5	889 (N)
<b>8894142*</b>	108 LEDs	41.7"	2.1"	1.25"	3.0	6.6	889 (N)



**8894142**  
In Strobe Mode

**2 LIGHTS IN ONE!**



**8894142**  
In Flood Light Mode



**6391207**

### Accessories

Part No.	Description	Wt. (lbs.)	Cat.
<b>6391207</b>	6-Switch Panel, Pre-Wired with LED Pattern Display, 6.5"L x 0.75"W x 2.75"T	0.39	639 (N)

Built-in traffic advisor controls.



**8894134** shown installed on Buyers Kabgard™ 85204



## LED Traffic Advisor/Strobe

**5-YEAR  
W**  
**12-24  
VOLTS**  
**IP  
67**

Number of Flash Patterns	11 Strobe 11 Traffic Arrows
Color	Amber
Lead Length	25'
Housing	Aluminum
Mount	Mounting Brackets Included

Mounting brackets can be set at various widths to accommodate a variety of applications.

Adjustable width mounting studs

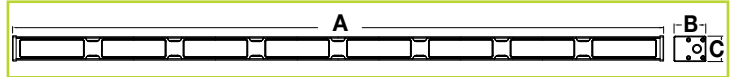

Part No.	LEDs	A	B	C	Amp	Wt. (lbs.)	Cat.
8894037	24	36.7"	2.25"	1.81"	3.2	6.6	889 (N)
8894047	32	46.5"	2.25"	1.81"	3.2	7.5	889 (N)



8894050 Riser Mounts



6391204



6391207



8894055



8894056

### Accessories

Part No.	Description	Wt. (lbs.)	Cat.
8894050	Optional L-Bracket Riser Mounts - 4.3" H	0.5	889 (N)

### Accessories

Part No.	Description	Wt. (lbs.)	Cat.
6391204	4-Switch Panel, Pre-Wired, 3.75"L x 1.25"W x 1.5"T	0.27	639 (N)
6391207	6-Switch Panel, Pre-Wired with LED Pattern Display, 6.5"L x 0.75"W x 2.75"T	0.39	639 (N)

Built-in traffic advisor controls.

### Accessories

Part No.	Description	Wt. (lbs.)	Cat.
8894055	8-Strand Bulk Wire, 25ft, For 8894037 & 8894047	2.25	889 (N)
8894056	8-Strand Bulk Wire, 50ft, For 8894037 & 8894047	4.5	889 (N)



8894047 shown installed on Buyers Kabgard™ 85204

# Strobe Lights

## Ultra-Thin 3.5" LED Strobe Light Series

**5-YEAR W**  
**12-24 VOLTS**  
**IP X8**  
**CA 13**

Number of LEDs	3
Housing	Aluminum
Number of Flash Patterns	12
Synchronous	Yes
Alternating	Yes



8892230

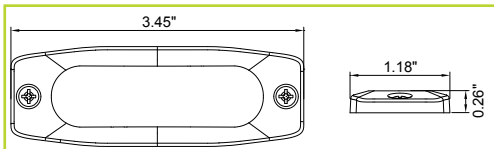

8892232

### SAE J595 Class 1 Lights

SAE J595  
CLASS 1

Part No.	Color	Amp	Wt. (lbs.)	Cat.
8892230	Amber	0.5	0.08	889 (N)
8892231	Clear	0.5	0.08	889 (N)
8892233	Red	0.5	0.08	889 (N)
8892234	Blue	0.5	0.08	889 (N)

Part No.	Color	Amp	Wt. (lbs.)	Cat.
8892239	Green	0.5	0.08	889 (N)

### Accessories

Part No.	Description	Wt. (lbs.)	Cat.
8892232	Black 90° Mounting Bracket For 8892230 Series Strobe Lights	0.04	889 (N)

## Ultra Thin 4.5" LED Strobe Light

**5-YEAR W**  
**12-24 VOLTS**  
**IP X8**  
**CA 13**

Number of LEDs	4
Housing	Aluminum
Number of Flash Patterns	23
Synchronous	Yes
Alternating	Yes



8892240

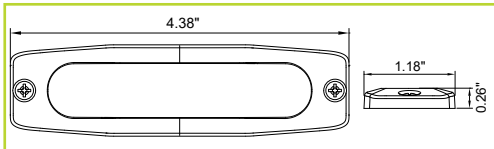

8892255

### SAE J595 Class 1 Lights

SAE J595  
CLASS 1

Part No.	Color	Amp	Wt. (lbs.)	Cat.
8892240	Amber	0.65	0.10	889 (N)
8892241	Clear	0.65	0.10	889 (N)
8892243	Red	0.65	0.10	889 (N)
8892244	Blue	0.65	0.10	889 (N)

Part No.	Color	Amp	Wt. (lbs.)	Cat.
8892242	Amber/Clear	0.65	0.10	889 (N)
8892245	Red/Blue	0.65	0.10	889 (N)
8892246	Red/Amber	0.65	0.10	889 (N)
8892247	Clear/Red	0.65	0.10	889 (N)
8892248	Blue/Amber	0.65	0.10	889 (N)
8892249	Green	0.65	0.10	889 (N)
8892250	Green/Amber	0.65	0.10	889 (N)

### Accessories

Part No.	Description	Wt. (lbs.)	Cat.
8892255	Black 90° Mounting Bracket For 8892240 Series Strobe Lights	0.04	889 (N)



SAE J595 CLASS 1

## Ultra Thin 5" LED Strobe Light

5-YEAR  
W  
12-24  
VOLTS  
IP  
X7  
CA  
13

Number of LEDs	6
Housing	Aluminum
Number of Flash Patterns	23
Synchronous	Yes
Alternating	Yes



8892200

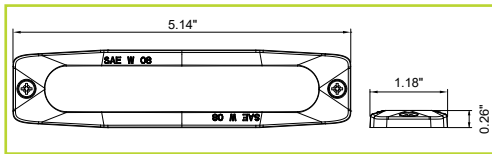

8892225

### SAE J595 Class 1 Lights

Part No.	Color	Amp	Wt. (lbs.)	Cat.
8892200	Amber	1.0	0.09	889 (N)
8892201	Clear	1.0	0.09	889 (N)
8892203	Red	1.0	0.09	889 (N)
8892204	Blue	1.0	0.09	889 (N)

Part No.	Color	Amp	Wt. (lbs.)	Cat.
8892202	Amber/Clear	1.0	0.09	889 (N)
8892205	Red/Blue	1.0	0.09	889 (N)
8892206	Amber/Red	1.0	0.09	889 (N)
8892207	Clear/Red	1.0	0.09	889 (N)
8892208	Amber/Blue	1.0	0.09	889 (N)
8892209	Green	1.0	0.09	889 (N)
8892210	Amber/Green	1.0	0.09	889 (N)

### Accessories

Part No.	Description	Wt. (lbs.)	Cat.
8892225	Black Mounting Bracket for 8892200 Series Strobe Lights	0.04	889 (N)

## Ultra Thin Dual Row 5" LED Strobe Light

5-YEAR  
W  
12-24  
VOLTS  
IP  
X7  
CA  
13

Number of LEDs	12
Housing	Aluminum
Number of Flash Patterns	30
Synchronous	Yes
Alternating	Yes



8890400

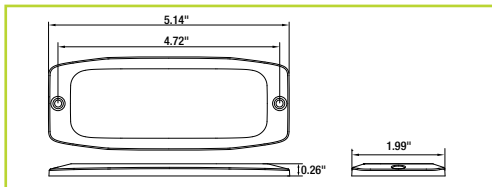

### SAE J595 Class 1 Lights

Part No.	Color	Amp	Wt. (lbs.)	Cat.
8890400	Amber	1.5	0.2	889 (N)
8890401	Clear	1.5	0.2	889 (N)
8890403	Red	1.5	0.2	889 (N)
8890404	Blue	1.5	0.2	889 (N)

Part No.	Color	Amp	Wt. (lbs.)	Cat.
8890402	Amber/Clear	1.5	0.2	889 (N)
8890405	Red/Blue	1.5	0.2	889 (N)
8890406	Amber/Red	1.5	0.2	889 (N)
8890407	Clear/Red	1.5	0.2	889 (N)
8890408	Amber/Blue	1.5	0.2	889 (N)
8890409	Green	1.5	0.2	889 (N)
8890410	Amber/Green	1.5	0.2	889 (N)



# Strobe Lights

## Ultra Thin Square 2" LED Strobe Light

5-YEAR  
**W**  
12-24  
**VOLTS**  
IP  
**X7**  
CA  
**13**

Number of LEDs	4
Housing	Aluminum
Number of Flash Patterns	18
Synchronous	Yes
Alternating	Yes



8892140

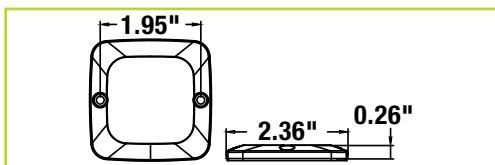

### SAE J595 Class 1 Lights

SAE J595  
**CLASS**  
**1**

	Part No.	Color	Amp	Wt. (lbs.)	Cat.
	8892140*	Amber	0.45	0.06	889 (N)
	8892141*	Clear	0.45	0.06	889 (N)

Available Q4

## Ultra Thin Wide Angle 4" LED Strobe Light

5-YEAR  
**W**  
12-24  
**VOLTS**  
IP  
**67**  
CA  
**13**

Number of LEDs	6
Housing	Aluminum
Number of Flash Patterns	16
Synchronous	Yes
Alternating	Yes

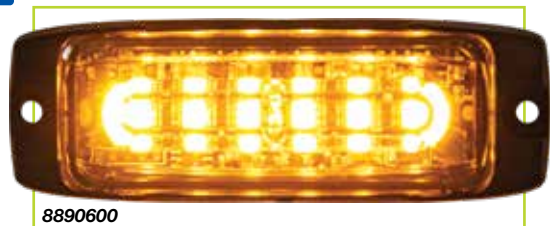

8890600

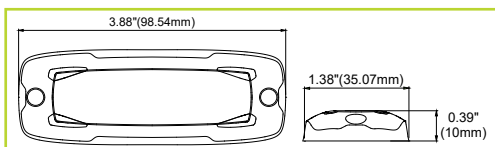

### SAE J595 Class 1 Lights

SAE J595  
**CLASS**  
**1**

	Part No.	Color	Amp	Wt. (lbs.)	Cat.
	8890600*	Amber	0.88	0.18	889 (N)
	8890601*	Clear	0.88	0.18	889 (N)



## Ultra Thin Wide Angle 5" Dual Color LED Strobe Light *Featured on Cover*

SAE J595  
CLASS 1

5-YEAR  
W  
12-24  
VOLTS  
IP  
67  
CA  
13

Number of LEDs	12
Housing	Aluminum
Number of Flash Patterns	See Chart
Synchronous	Yes
Alternating	Yes



8890300

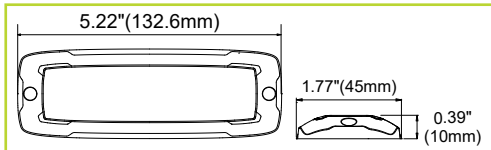



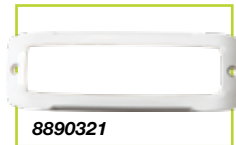













8890320





8890321

### SAE J595 Class 1 Lights

	Part No.	Color	Amp	Flash	Wt. (lbs.)	Cat.
	 8890300	Amber	0.88	16	0.24	889 (N)
	 8890301	Clear	0.88	16	0.24	889 (N)

	Part No.	Color	Amp	Flash	Wt. (lbs.)	Cat.
	 8890302	Amber/Clear	0.88	26	0.24	889 (N)
	 8890305	Red/Blue	0.88	26	0.24	889 (N)
	 8890306	Amber/Red	0.88	26	0.24	889 (N)
	 8890307	Clear/Red	0.88	26	0.24	889 (N)
	 8890308	Amber/Blue	0.88	26	0.24	889 (N)
	 8890310	Amber/Green	0.88	26	0.24	889 (N)

### Accessories

	Part No.	Description	Wt. (lbs.)	Cat.
	8890320	Chrome Bezel For 8890300 Series Strobe Lights	0.04	889 (N)
	8890321	White Bezel For 8890300 Series Strobe Lights	0.04	889 (N)

## Thin 3.5" LED Strobe Light

SAE J595  
CLASS 1

5-YEAR  
W  
12-24  
VOLTS  
IP  
67  
CA  
13

Number of LEDs	3
Housing	Aluminum
Number of Flash Patterns	12
Synchronous	Yes
Alternating	Yes



8892300

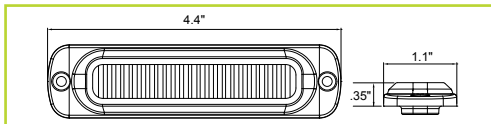

8892320







8892321





8892325



### SAE J595 Class 1 Lights

	Part No.	Color	Amp	Wt. (lbs.)	Cat.
	 8892300	Amber	0.24	0.11	889 (N)
	 8892301	Clear	0.24	0.11	889 (N)

*Strobes must be mounted in horizontal orientation to achieve Class 1 rating*

	Part No.	Color	Amp	Wt. (lbs.)	Cat.
	 8892309	Green	0.24	0.11	889 (N)

### Accessories

	Part No.	Description	Wt. (lbs.)	Cat.
	8892320	Chrome Bezel for Thin Mount LED Lights	0.02	889 (N)
	8892321	White PVC Bezel for Thin Mount LED Lights	0.03	889 (N)
	8892325	Black, 90 Degree Mounting Bracket	0.06	889 (N)

# Strobe Lights

## Thin 4.5" Horizontal Dual Color LED Strobe Light

**5-YEAR  
W**  
**12-24  
VOLTS**  
**IP  
67**

Number of LEDs	12
Housing	Aluminum
Number of Flash Patterns	28
Synchronous	Yes
Alternating	Yes



8892102

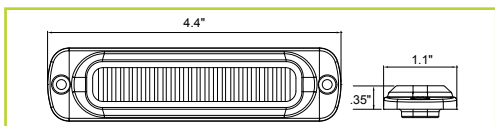

8891920



8891921



8891925

### SAE J595 Class 1 Lights

SAE J595  
CLASS  
1

	Part No.	Color	Amp	Wt. (lbs.)	Cat.
	8892102	Clear/Amber	1.0	0.15	889 (N)
	8892105	Red/Blue	1.0	0.15	889 (N)
	8892106	Amber/Red	1.0	0.15	889 (N)
	8892107	Red/Clear	1.0	0.15	889 (N)
	8892108	Amber/Blue	1.0	0.15	889 (N)
	8892109	Amber/Green	1.0	0.15	889 (N)

*Strobes must be mounted in horizontal orientation to achieve Class 1 rating*

### Accessories

	Part No.	Description	Wt. (lbs.)	Cat.
	8891920	Chrome Bezel for Thin Mount LED Lights	0.02	889 (N)
	8891921	White PVC Bezel for Thin Mount LED Lights	0.03	889 (N)
	8891925	Black, 90 Degree Mounting Bracket	0.06	889 (N)

## Thin 4.5" Horizontal LED Strobe Light

**5-YEAR  
W**  
**12-24  
VOLTS**  
**IP  
67**

Number of LEDs	6
Housing	Aluminum
Number of Flash Patterns	19
Synchronous	Yes
Alternating	Yes



8891900

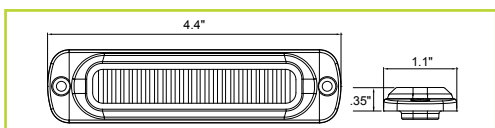

8891920



8891921



8891925

### SAE J595 Class 1 Lights

SAE J595  
CLASS  
1

	Part No.	Color	Amp	Wt. (lbs.)	Cat.
	8891900	Amber	1.0	0.15	889 (N)
	8891901	Clear	1.0	0.15	889 (N)
	8891903	Red	1.0	0.15	889 (N)
	8891904	Blue	1.0	0.15	889 (N)

*Strobes must be mounted in horizontal orientation to achieve Class 1 rating*

	Part No.	Color	Amp	Wt. (lbs.)	Cat.
	8891902	Amber/Clear	1.0	0.15	889 (N)
	8891909	Green	1.0	0.15	889 (N)

### Accessories

	Part No.	Description	Wt. (lbs.)	Cat.
	8891920	Chrome Bezel for Thin Mount LED Lights	0.02	889 (N)
	8891921	White PVC Bezel for Thin Mount LED Lights	0.03	889 (N)
	8891925	Black, 90 Degree Mounting Bracket	0.06	889 (N)





## Thin 4.5" Vertical LED Strobe Light



Number of LEDs	6
Housing	Aluminum
Number of Flash Patterns	19
Synchronous	Yes
Alternating	Yes

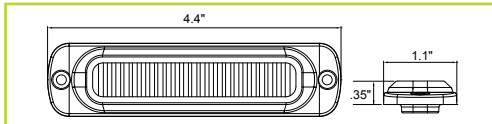

### SAE J595 Class 1 Lights



	Part No.	Color	Amp	Wt. (lbs.)	Cat.
	8891910	Amber	1.0	0.15	889 (N)
	8891911	Clear	1.0	0.15	889 (N)
	8891913	Red	1.0	0.15	889 (N)
	8891914	Blue	1.0	0.15	889 (N)

Strobes must be mounted in vertical orientation to achieve Class 1 rating

	Part No.	Color	Amp	Wt. (lbs.)	Cat.
	8891912	Amber/Clear	1.0	0.15	889 (N)
	8891919	Green	1.0	0.15	889 (N)

### Accessories

	Part No.	Description	Wt. (lbs.)	Cat.
	8891920	Chrome Bezel for Thin Mount LED Lights	0.02	889 (N)
	8891921	White PVC Bezel for Thin Mount LED Lights	0.03	889 (N)
	8891925	Black, 90 Degree Mounting Bracket	0.06	889 (N)

## Thin Dual Row 4.5" LED Strobe Light



Number of LEDs	12
Housing	Aluminum
Number of Flash Patterns	25
Synchronous	Yes
Alternating	Yes

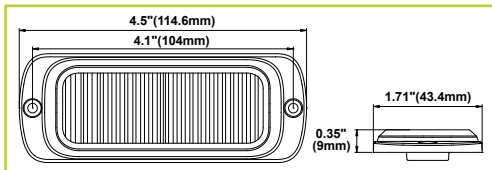
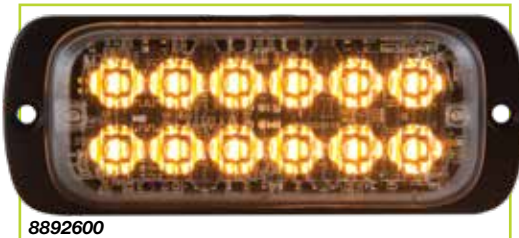

### SAE J595 Class 1 Lights



	Part No.	Color	Amp	Wt. (lbs.)	Cat.
	8892600	Amber	0.78	0.21	889 (N)
	8892602	Amber/Clear	0.78	0.21	889 (N)
	8892609	Green	0.78	0.21	889 (N)

### Accessories

	Part No.	Description	Wt. (lbs.)	Cat.
	8892620	Chrome Bezel for Thin Mount LED Lights	0.02	889 (N)

# Strobe Lights

## 2.5" LED Strobe Light

**5-YEAR W**  
**12-24 VOLTS**  
**IP 67**

Number of LEDs	3
Housing	Aluminum
Number of Flash Patterns	12
Synchronous	Yes
Alternating	Yes



8891403

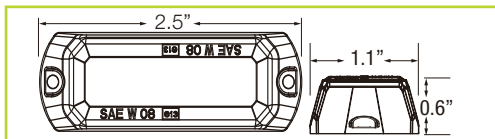

### SAE J595 Class 2 Lights

SAE J595  
CLASS 2

	Part No.	Color	Amp	Wt. (lbs.)	Cat.
	8891403	Amber	0.22	0.33	889 (N)
	8891404	Clear	0.22	0.33	889 (N)

## 3.5" LED Strobe Light

**5-YEAR W**  
**12-24 VOLTS**  
**IP 67**

Number of LEDs	3
Housing	Aluminum
Number of Flash Patterns	12
Synchronous	Yes
Alternating	Yes



8891400

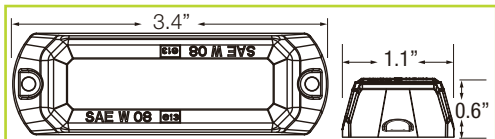

### SAE J595 Class 2 Lights

SAE J595  
CLASS 2

	Part No.	Color	Amp	Wt. (lbs.)	Cat.
	8891400	Amber	0.22	0.17	889 (N)
	8891401	Clear	0.22	0.17	889 (N)

### Accessories

	Part No.	Description	Wt. (lbs.)	Cat.
	8891402	Black, 90 Degree Mounting Bracket for 8891400 and 8891401	0.08	889 (N)
	8891405	Black Grommet for Recessed Mounting, 3-3/8"	0.04	889 (N)



SAE J595  
CLASS  
1



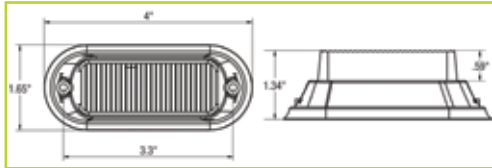

## 4" LED Strobe Light

5-YEAR  
**W**  
12-24  
VOLTS  
IP  
67

Number of LEDs	3
Housing	Plastic
Number of Flash Patterns	19
Synchronous	Yes
Alternating	Yes



### SAE J595 Class 1 Lights

	Part No.	Color	Amp	Wt. (lbs.)	Cat.	
		8891120	Amber	0.3	0.20	889 (N)
		8891121	Clear	0.3	0.20	889 (N)

### Accessories

Part No.	Description	Wt. (lbs.)	Cat.
	8891135 Mounting Bracket for 8891120/8891121, Black	0.08	889 (N)

## 5" LED Mini Strobe Light Series



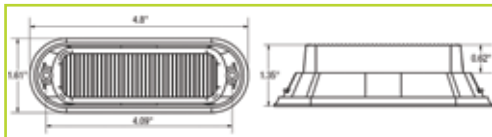

5-YEAR  
**W**  
12-24  
VOLTS  
IP  
67

Number of LEDs	4
Housing	Plastic
Number of Flash Patterns	19
Synchronous	Yes
Alternating	Yes



### SAE J595 Class 1 Lights

SAE J595  
CLASS  
1

	Part No.	Color	Amp	Wt. (lbs.)	Cat.	
		8891130	Amber	0.4	0.24	889 (N)
		8891131	Clear	0.4	0.24	889 (N)

Part No.	Color	Amp	Wt. (lbs.)	Cat.
	8891132 Amber/Clear	0.4	0.24	889 (N)

### Accessories

Part No.	Description	Wt. (lbs.)	Cat.
	8891135 Black, 90 Degree Mounting Bracket for 8891130 Series	0.08	889 (N)



# Strobe Lights

## 5" LED Strobe Light

**5-YEAR W**  
**12-24 VOLTS**  
**IP 67**  
**CA 13**

Number of LEDs	6
Housing	Aluminum
Number of Flash Patterns	19
Synchronous	Yes
Alternating	Yes



8891500

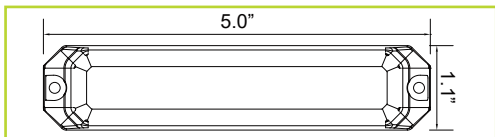

8891505



8891506

### SAE J595 Class 1 Lights

SAE J595  
CLASS 1

	Part No.	Color	Amp	Wt. (lbs.)	Cat.
	8891500	Amber	1.1	0.25	889 (N)
	8891501	Clear	1.1	0.25	889 (N)

	Part No.	Color	Amp	Wt. (lbs.)	Cat.
	8891502	Amber/Clear	1.1	0.25	889 (N)
	8891509	Green	1.1	0.25	889 (N)

### Accessories

	Part No.	Description	Wt. (lbs.)	Cat.
	8891505	Grommet	0.25	889 (N)
	8891506	Black, 90 Degree Mounting Bracket for 8891500 Series	0.16	889 (N)

## 5" Raised LED Strobe Light

**5-YEAR W**  
**12-24 VOLTS**  
**IP 67**

Number of LEDs	4
Housing	Aluminum
Number of Flash Patterns	See Chart
Synchronous	Yes
Alternating	Yes



8891104

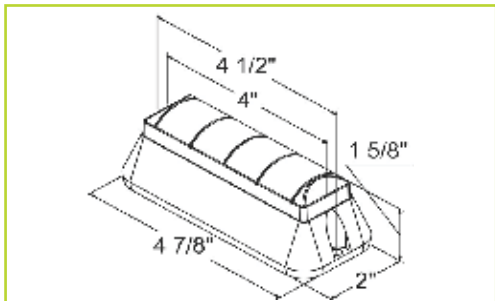

8891007

### SAE J595 Class 2 Lights with 1 Flash Pattern

SAE J595  
CLASS 2

	Part No.	Color	Flash	Amp	Wt. (lbs.)	Cat.
	8891004**	Amber	1	0.54	0.60	889 (N)
	8891006**	Clear	1	0.54	0.60	889 (N)

\*\*Does not feature alternating and synchronous functions

### SAE J595 Class 2 Lights with 19 Flash Patterns

SAE J595  
CLASS 2

	Part No.	Color	Flash	Amp	Wt. (lbs.)	Cat.
	8891104	Amber	19	0.54	0.60	889 (N)
	8891105	Amber/Clear	19	0.54	0.60	889 (N)

### Accessories

	Part No.	Description	Wt. (lbs.)	Cat.
	8891007	Aluminum, 90 Degree Mounting Bracket	0.16	889 (N)



SAE J595  
CLASS  
1

## Narrow Profile 5" LED Strobe Light

5-YEAR  
W  
12-24  
VOLTS  
IP  
X7  
CA  
13

Number of LEDs	3
Housing	Aluminum
Number of Flash Patterns	12
Synchronous	Yes
Alternating	Yes

Mounts in the narrow spacing in a vehicle's front grill or between the rear bumper and tailgate of pickup trucks



8892700

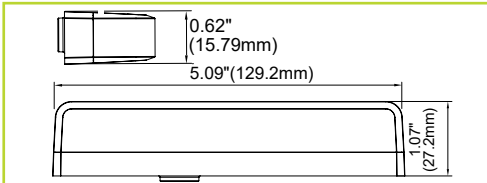

8892825

### SAE J595 Class 1 Lights

	Part No.	Color	Amp	Wt. (lbs.)	Cat.
	8892700	Amber	0.74	0.29	889 (N)
	8892701	Clear	0.74	0.29	889 (N)
	8892703	Red	0.74	0.29	889 (N)
	8892704	Blue	0.74	0.29	889 (N)

	Part No.	Color	Amp	Wt. (lbs.)	Cat.
	8892709	Green	0.74	0.29	889 (N)

### Accessories

	Part No.	Description	Wt. (lbs.)	Cat.
	8892825	Dash Bracket Housing	0.12	889 (N)

## Ultra Bright Narrow Profile 5" LED Strobe Light

5-YEAR  
W  
12-24  
VOLTS  
IP  
X7  
CA  
13

Number of LEDs	6
Housing	Aluminum
Number of Flash Patterns	23
Synchronous	Yes
Alternating	Yes

Mounts in the narrow spacing in a vehicle's front grill or between the rear bumper and tailgate of pickup trucks



8892800

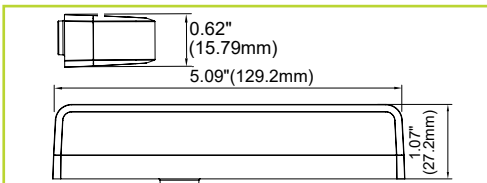

8892825

### SAE J595 Class 1 Lights

SAE J595  
CLASS  
1

	Part No.	Color	Amp	Wt. (lbs.)	Cat.
	8892800	Amber	1.14	0.29	889 (N)
	8892801	Clear	1.14	0.29	889 (N)

	Part No.	Color	Amp	Wt. (lbs.)	Cat.
	8892802	Amber/Clear	1.14	0.29	889 (N)
	8892805	Red/Blue	1.14	0.29	889 (N)
	8892809	Green	1.14	0.29	889 (N)
	8892810	Amber/Green	1.14	0.29	889 (N)

### Accessories

	Part No.	Description	Wt. (lbs.)	Cat.
	8892825	Dash Bracket Housing	0.12	889 (N)



8892800 and 8892801 shown

# Strobe Lights

## Dual Row 5" LED Strobe Light

**5-YEAR  
W**  
**12-24  
VOLTS**  
**IP  
67**  
**CA  
13**

Number of LEDs	12
Housing	Aluminum
Number of Flash Patterns	25
Synchronous	Yes
Alternating	Yes

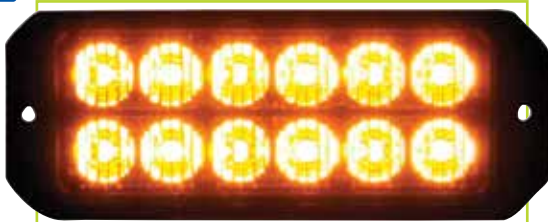

8891700

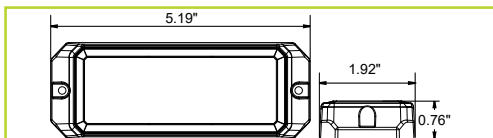

8891705



8891711



8891706

## SAE J595 Class 1 Lights

SAE J595  
CLASS  
1

	Part No.	Color	Amp	Wt. (lbs.)	Cat.
	8891700	Amber	2.2	0.42	889 (N)
	8891701	Clear	2.2	0.42	889 (N)
	8891702	Amber/Clear	2.2	0.42	889 (N)
	8891709	Amber/Green	2.2	0.42	889 (N)
	8891710	Green	2.2	0.42	889 (N)

## Accessories

	Part No.	Description	Wt. (lbs.)	Cat.
	8891705	Recessed Mount, Black Grommet for 8891700 Series	0.12	889 (N)
	8891711	Recessed Mount, Black Grommet for 8891700 Series, fits in 6" Oval	0.12	889 (N)
	8891706	Black, 90 Degree Mounting Bracket	0.70	889 (N)

## Dual Row 5.5" LED Strobe Light

**5-YEAR  
W**  
**12-24  
VOLTS**  
**IP  
67**

Number of LEDs	12
Housing	Plastic
Number of Flash Patterns	12
Synchronous	Yes
Alternating	Yes



8891600

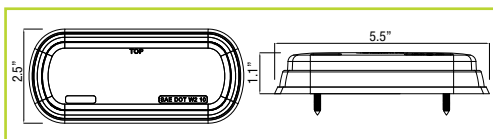

8891705

	Part No.	Color	Amp	Wt. (lbs.)	Cat.
	8891600	Amber	1.0	0.42	889 (N)
	8891602	Amber/Clear	1.0	0.42	889 (N)

## Accessories

	Part No.	Description	Wt. (lbs.)	Cat.
	8891605	Aluminum, 90 Degree Mounting Bracket	0.16	889 (N)





## Post Mounted 3" LED Strobe SAE J595 Class 1 Light



Number of LEDs	4
Housing	Aluminum
Number of Flash Patterns	19
Synchronous	Yes
Alternating	Yes

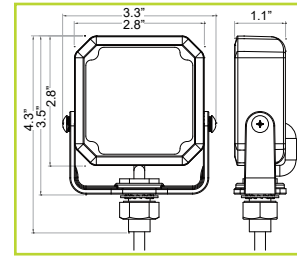

Part No.	Color	Amp	Wt. (lbs.)	Cat.
8891800	Amber	0.55	0.65	889 (N)

## Post Mounted 4.5" LED Strobe Light



Number of LEDs	6
Housing	Aluminum
Number of Flash Patterns	1
Synchronous	Yes
Alternating	Yes

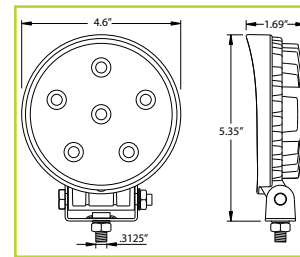

Part No.	Color	Amp	Wt. (lbs.)	Cat.
8891015	Amber	1.5	1.20	889 (N)

## Quad Row 5" LED Strobe SAE J595 Class 1 Light



Number of LEDs	16
Housing	Aluminum
Number of Flash Patterns	10
Synchronous	Yes
Alternating	Yes



8890202

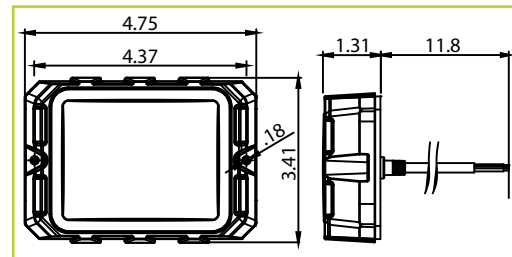

Part No.	Color	Amp	Wt. (lbs.)	Cat.
8890200	Amber	1.0	0.76	889 (N)
8890202	Amber/Clear	1.0	0.76	889 (N)

# Surface Mounted LED Strobe Lights

## 1.5" Flush/Surface Mount LED Strobe Light Series



Number of LEDs	6
Housing	Aluminum
Mount	Flush or Surface
Number of Flash Patterns	17
Synchronous	Yes
Alternating	Yes

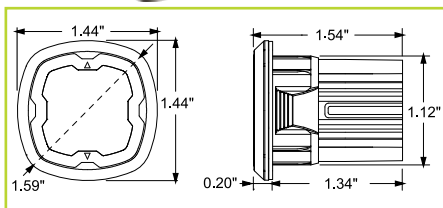

### SAE J595 Class 1 Lights



	Part No.	Color	Amp	Lead	Wt. (lbs.)	Cat.
	8892410*	Amber	1.62	9.5"	0.10	889 (N)
	8892411*	Clear	1.62	9.5"	0.10	889 (N)

1 lighthead per box.  
Available Q4

### Accessories

	Part No.	Description	Wt. (lbs.)	Cat.
	8892426*	Mounting Bracket Pair	0.10	889 (N)

Available Q4

## Surface/Recess Mount LED Strobe Light Series



Number of LEDs	3
Housing	Aluminum
Number of Flash Patterns	16
Synchronous	Yes
Alternating	Yes

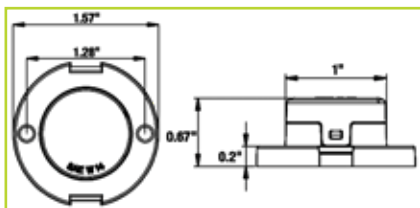

### SAE J595 Class 1 Lights



	Part No.	Color	Amp	Lead	Wt. (lbs.)	Cat.
	8892400	Amber	0.47	9.5"	0.10	889 (N)
	8892401	Clear	0.47	9.5"	0.10	889 (N)

1 lighthead per box, includes black bezel.

### Accessories

	Part No.	Description	Wt. (lbs.)	Cat.
	8892420	Chrome Bezel	0.10	889 (N)
	8892425	Black Aluminum Mounting Bracket, 90 Degree	0.05	889 (N)



## Bolt-On Hidden LED Strobe Kits with In-Line Flashers

**5-YEAR**  
**W**  
**12**  
**VOLTS**

Number of LEDs	6
Housing	Aluminum
Number of Flash Patterns	19
Synchronous	Yes
Alternating	Yes

Note: Up to six 8891215-8891327 can be combined for synchronized or alternating flash patterns

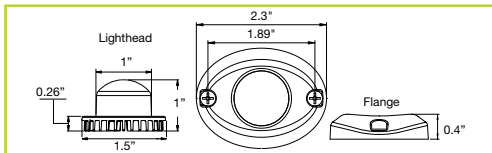

	Part No.	Color	Amp	Lead	Wt. (lbs.)	Cat.
	8891215	Clear	1.3	15'	1.25	889 (N)
	8891225	Clear	1.3	25'	1.60	889 (N)
	8891216	Amber	1.3	15'	1.25	889 (N)
	8891226	Amber	1.3	25'	1.60	889 (N)
	8891227	Amber/Clear	1.3	25'	1.60	889 (N)

2 lighthead per box.  
1 pair of 8891201 mounting bezels included.

### Accessories

	Part No.	Description	Wt. (lbs.)	Cat.
	8891200	1 Pair, Chrome, Surface Mount Bezels for Bolt-On Hidden Strobes	0.04	889 (N)
	8891201	1 Pair, Black, Surface Mount Bezels for Bolt-On Hidden Strobes	0.04	889 (N)

## Push-On Hidden Strobe Kit with In-Line Flashers

**5-YEAR**  
**W**  
**12**  
**VOLTS**

Number of LEDs	6
Housing	Aluminum
Number of Flash Patterns	19
Synchronous	Yes
Alternating	Yes

Note: Up to six 8891215-8891327 can be combined for synchronized or alternating flash patterns

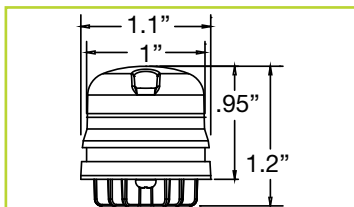
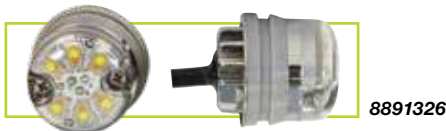

	Part No.	Color	Amp	Size	Wt. (lbs.)	Cat.
	8891325	Amber	1.3	25'	1.60	889 (N)
	8891326	Clear	1.3	25'	1.60	889 (N)
	8891327	Amber/Clear	1.3	25'	1.60	889 (N)

2 lighthead per box.  
1 pair surface mount bezel included.



# Strobe Lights

## LED Cab Marker Strobe Replacement Kit Series

12-24  
VOLTS  
IP  
68

Input Power	100W
Connection	Blunt Cut
Color	Amber
Main Material	Aluminum
Operating Life	30000+ HRS
Operating Temperature	(-40° ~ +185°F)



Replaces your OEM cab lights with versatile marker/strobes. 8892013 shown installed.

### Marker/Strobe OEM Replacement Light Kit for Ford® Superduty Pickups (2017+)



Part No.	LEDs	Lumens	Wt. (lbs.)	Cat.
8892003	105 for Set	4,000 for Set	2.50	889 (N)

### Marker/Strobe OEM Replacement Light Kit for GM®/Chevrolet® Trucks (2015-2019)



Part No.	LEDs	Lumens	Wt. (lbs.)	Cat.
8892010	201 for Set	2,200 for Set	3.60	889 (N)

### Marker/Strobe OEM Replacement Light Kit for Dodge/RAM® 2500-3500 Pickups (2003-2018-1/2)



Part No.	LEDs	Lumens	Wt. (lbs.)	Cat.
8892013	390 for Set	4,000 for Set	3.70	889 (N)



## Hideaway Strobe Conversion Kit for OEM Pickup Lights

**12**  
VOLTS  
**IP**  
68

Input Power	90W
Number of Flasher Patterns	6
Main Material	Aluminum
Operating Life	30000+ HRS
Operating Temperature	(-40° ~ +185°F)

Vehicle must have LED bulbs in order to use this system.



The plug-and-play kit is easy to install without modifying your vehicle. It uses the same wiring and mounting holes as your truck's factory lights - no drilling holes or cutting wires required.



Turn your factory LED cargo lights, reverse lights, and mirror turn signals into warning lights. *(Select models only)*

### Conversion Kit for Ford Steel Cab



Part No.	Description	Wt. (lbs.)	Cat.
 8890500	For Ford Steel Cab (F-150: 2010-2015), (F-650 to F-750: 2011+), (Ford SuperDuty 2011-2016)	1.75	889 (N)

### Conversion Kit for Ford Aluminum Cab



Part No.	Description	Wt. (lbs.)	Cat.
 8890501	For Ford Aluminum Cab (F-150: 2015-1/2+ and Ford SuperDuty 2017+)	1.75	889 (N)

### Conversion Kit for GMC/Chevy



Part No.	Description	Wt. (lbs.)	Cat.
 8890510	For GMC/Chevy (1500-3500, Tahoe/Suburban/Yukon/Cadillac Escalade) 2014-2019	1.75	889 (N)

# LED Combination Stop/Turn/Tail/Backup Strobe Lights

## 4" Round LED Multi-Mount Stop/Turn/Tail/Backup/Strobe

<b>5-YEAR W</b>	Number of LEDs	32
	Housing	Plastic
<b>12-24 VOLTS</b>	Number of Flash Patterns	19
	Synchronous	Yes
<b>IP 69</b>	Alternating	Yes
	<b>CA 13</b>	

Grommet is for recessed and chrome cover for surface mounting.

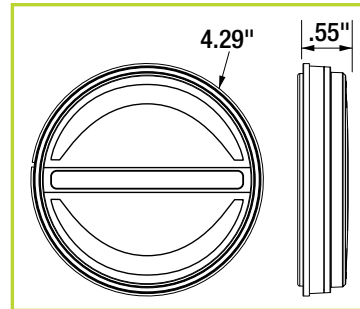

Shown in Stop/Turn/Tail/Backup mode with grommet and in Strobe mode without grommet

### SAE J595 Class 1 Lights

SAE J595  
CLASS  
1

Part No.	Color	Amp	Wt. (lbs.)	Cat.
5624432	Red/Clear/ Amber	1.3	0.50	889 (N)

## 6" Oval LED Multi-Mount Stop/Turn/Tail/Backup/Strobe

<b>5-YEAR W</b>	Number of LEDs	32
	Housing	Plastic
<b>12-24 VOLTS</b>	Number of Flash Patterns	19
	Synchronous	Yes
<b>IP 69</b>	Alternating	Yes
	<b>CA 13</b>	

Grommet is for recessed and chrome cover for surface mounting.

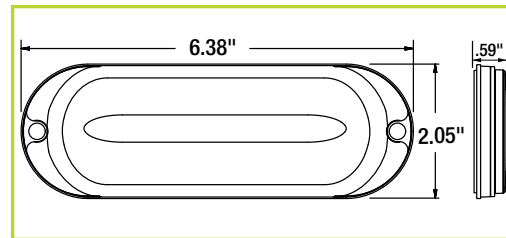

Shown in Stop/Turn/Tail/Backup mode with grommet and in Strobe mode without grommet

### SAE J595 Class 1 Lights

SAE J595  
CLASS  
1

Part No.	Color	Amp	Wt. (lbs.)	Cat.
5626432	Red/Clear/ Amber	1.3	0.60	889 (N)





## 4" Round LED Recessed Strobe Light

**5-YEAR  
W**  
**12-24  
VOLTS**  
**IP  
67**

Number of LEDs	24
Housing	Plastic
Number of Flash Patterns	See Chart
Synchronous	Yes
Alternating	Yes

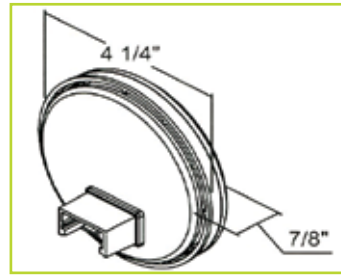

	Part No.	Color	Flash	Amp	Wt. (lbs.)	Cat.
	SL40AR	Amber	Six Flash	0.50	0.40	889 (N)
	SL41AR	Amber	Quad Flash	0.50	0.40	889 (N)

## 6" Oval LED Recessed Strobe Light

**5-YEAR  
W**  
**12-24  
VOLTS**  
**IP  
67**

Number of LEDs	24
Housing	Plastic
Number of Flash Patterns	6
Synchronous	Yes
Alternating	Yes

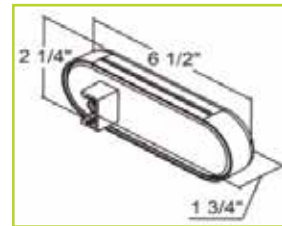

	Part No.	Color	Amp	Wt. (lbs.)	Cat.
	SL65AO	Amber	0.50	0.70	889 (N)
	SL65CO	Clear	0.50	0.70	889 (N)

## 6" Quad Flash Oval Recessed Strobe Light Series

**5-YEAR  
W**  
**12-24  
VOLTS**  
**IP  
67**

Number of LEDs	24
Housing	Plastic
Quad Flash	Yes
Synchronous	Yes
Alternating	Yes

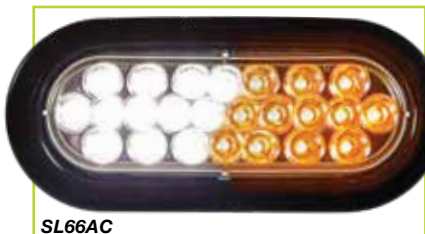
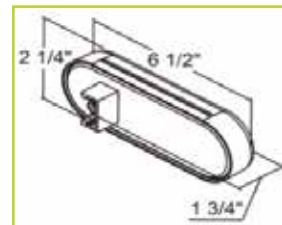

	Part No.	Color	Amp	Wt. (lbs.)	Cat.
	SL66AC	Amber/Clear	0.50	0.70	889 (N)
	SL66AG	Amber/Green	0.50	0.70	889 (N)
	SL66AO	Amber with Amber Lens	0.50	0.70	889 (N)
	SL66CA	Amber with Clear Lens	0.50	0.70	889 (N)
	SL66CG	Clear/Green	0.50	0.70	889 (N)
	SL66GO	Green	0.50	0.70	889 (N)

# Beacon Lights

## Low Profile Class 1 6" LED Beacon

5-YEAR  
**W**  
12-24  
**VOLTS**  
SAE J845  
CLASS  
**1**

Number of LEDs	12
Number of Flash Patterns	3

See pg. 77 for Drill-Free Cab Mount Options

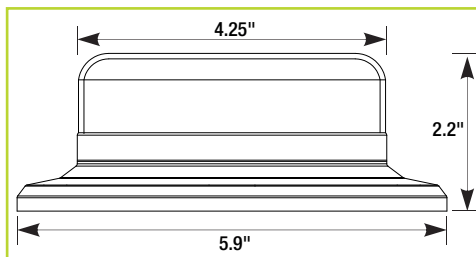

### SAE J845 Class 1 Beacon, Auxiliary Power Plug

Part No.	Color	Lead	Mounting	Amp	Wt. (lbs.)	Cat.
SL550ALP	Amber	15' ON/OFF Switch	Permanent and Magnetic	1.0	1.46	889 (N)



### SAE J845 Class 1 Beacon, Hard-wired

Part No.	Color	Lead	Mounting	Amp	Wt. (lbs.)	Cat.
SL551ALP	Amber	13" Blunt Cut	Permanent	1.0	1.08	889 (N)

## Low Profile Class 1 8" LED Beacon

5-YEAR  
**W**  
12-24  
**VOLTS**  
IP  
**67**  
CA  
**13**  
SAE J845  
CLASS  
**1**

Number of LEDs	15
Number of Flash Patterns	11

See pg. 77 for Drill-Free Cab Mount Options

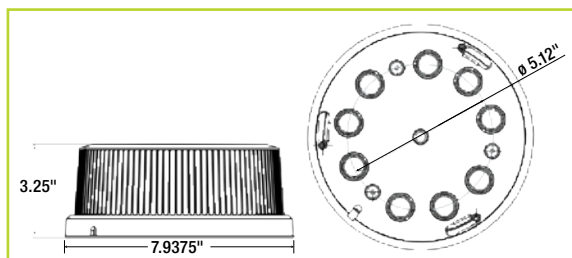

### SAE J845 Class 1 Beacon

Part No.	Color	Lead	Mounting	Amp	Wt. (lbs.)	Cat.
SL700A	Amber	10" Blunt Cut	Permanent	2.0	3.0	889 (N)



## Class 1 7" LED Beacon with Upward Facing LEDs

5-YEAR  
**W**  
12-24  
**VOLTS**  
IP  
**67**  
CA  
**13**  
SAE J845  
CLASS  
**1**

Number of LEDs	36 (12 Upward Facing)
Number of Flash Patterns	14

Can be mounted with 3 bolts or 1" pipe.  
See pg. 77 for Drill-Free Cab Mount Options

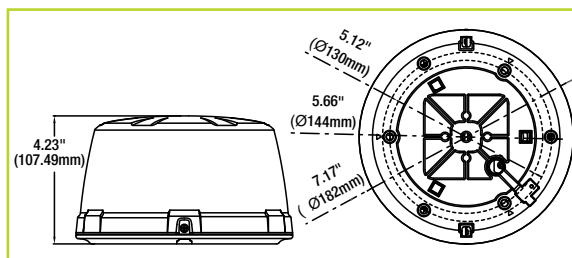

### SAE J845 Class 1 Beacon

Part No.	Color	Lead	Mounting	Amp	Wt. (lbs.)	Cat.
SL800A	Amber	10" Blunt Cut	Permanent	5.56	2.88	889 (N)



## Class 1 5.5" x 4.5" LED Beacon

5-YEAR  
**W**  
12-24  
**VOLTS**  
IP  
**X6**  
SAE J845  
CLASS  
**1**

Number of LEDs	15
Number of Flash Patterns	11

See pg. 77 for Drill-Free Cab Mount Options

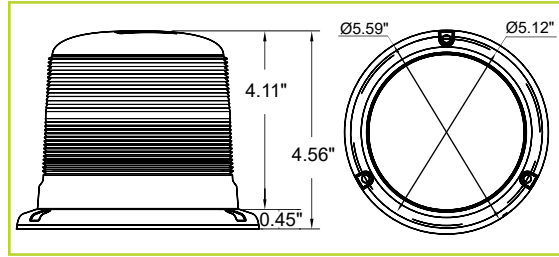

### SAE J845 Class 1 Amber Beacon

Part No.	Color	Lead	Mounting	Amp	Wt. (lbs.)	Cat.
SL585ALP	Amber	11" Blunt Cut	Permanent	1.86	1.31	889 (N)

### SAE J845 Class 1 Blue Beacon

Part No.	Color	Lead	Mounting	Amp	Wt. (lbs.)	Cat.
SL585BLP	Blue	11" Blunt Cut	Permanent	1.86	1.31	889 (N)

## Class 1 6.5" x 5" LED Beacon

5-YEAR  
**W**  
12-24  
**VOLTS**  
SAE J845  
CLASS  
**1**

Number of LEDs	12
Number of Flash Patterns	8

See pg. 77 for Drill-Free Cab Mount Options

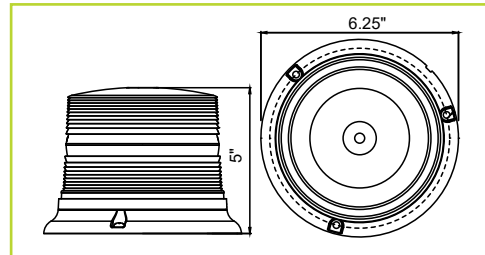

### SAE J845 Class 1 Beacon

Part No.	Color	Lead	Mounting	Amp	Wt. (lbs.)	Cat.
SL645ALP	Amber	10' ON/OFF switch	Permanent, Pipe, and Magnetic	1.5	2.4	889 (N)

## Class 1 6.5" x 6.5" LED Beacon

5-YEAR  
**W**  
12-24  
**VOLTS**  
SAE J845  
CLASS  
**1**

Number of LEDs	6
Number of Flash Patterns	10

See pg. 77 for Drill-Free Cab Mount Options

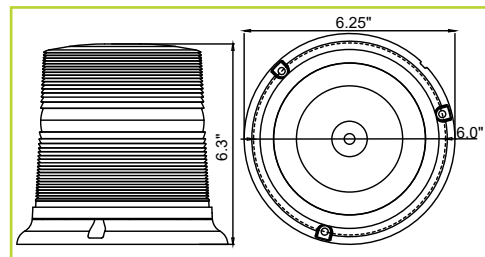

### SAE J845 Class 1 Beacon

Part No.	Color	Lead	Mounting	Amp	Wt. (lbs.)	Cat.
SL665A	Amber	10' ON/OFF Switch	Permanent, Pipe, and Magnetic	1.5	2.7	889 (N)



# Beacon Lights

## Class 1 6.5" x 5" LED Beacon

5-YEAR  
**W**  
12-24  
**VOLTS**  
SAE J845  
CLASS  
**1**

Number of LEDs	8
Number of Flash Patterns	15

See pg. 77 for Drill-Free Cab Mount Options

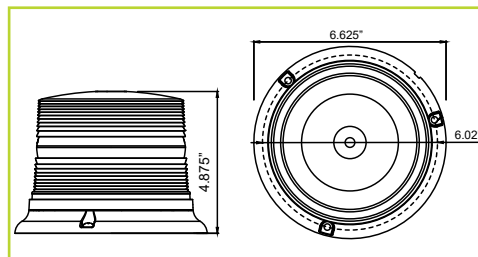

### SAE J845 Class 1 Beacon, Auxiliary Power Plug

Part No.	Color	Lead	Mounting	Amp	Wt. (lbs.)	Cat.
SL675ALP	Amber	10' ON/OFF Switch	Permanent and Magnetic	1.5	2.35	889 (N)

### SAE J845 Class 1 Beacon, Hard-wired

Part No.	Color	Lead	Mounting	Amp	Wt. (lbs.)	Cat.
SL685ALP	Amber	9" Blunt Cut	Permanent and Pipe	1.5	1.63	889 (N)

## Class 1 6.5" x 6.5" LED Beacon

5-YEAR  
**W**  
12-24  
**VOLTS**  
CA  
**13**  
SAE J845  
CLASS  
**1**

Number of LEDs	12
Number of Flash Patterns	12

See pg. 77 for Drill-Free Cab Mount Options

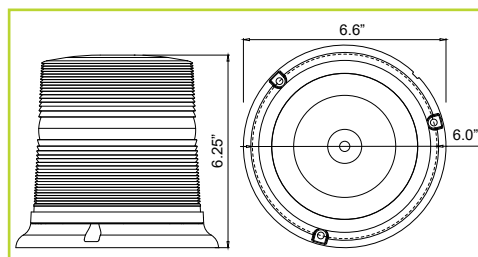

### SAE J845 Class 1 Beacon, Auxiliary Power Plug

Part No.	Color	Lead	Mounting	Amp	Wt. (lbs.)	Cat.
SL695A	Amber	10' ON/OFF Switch	Permanent and Magnetic	2.7	2.67	889 (N)

### SAE J845 Class 1 Beacon, Hard-wired

Part No.	Color	Lead	Mounting	Amp	Wt. (lbs.)	Cat.
SL696A	Amber	12" Blunt Cut	Permanent and Pipe	2.7	1.95	889 (N)

## Class 1 5" x 4" LED Beacon

5-YEAR  
**W**  
12-24  
**VOLTS**  
SAE J845  
CLASS  
**1**

Number of LEDs	32
Number of Flash Patterns	8

See pg. 77 for Drill-Free Cab Mount Options

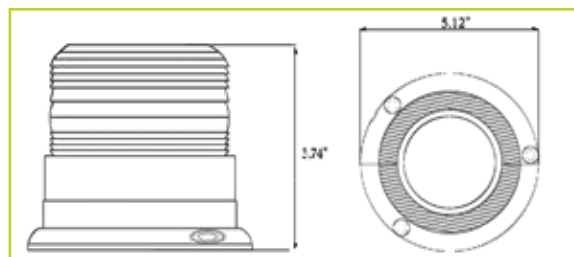

### SAE J845 Class 1 Beacon

Part No.	Color	Lead	Mounting	Amp	Wt. (lbs.)	Cat.
SL502A	Amber	10' ON/OFF Switch	Permanent and Magnetic	1.4	1.16	889 (N)



## Class 2 6.5" x 5" LED Beacon

5-YEAR  
**W**  
12-24  
**VOLTS**  
SAE J848  
CLASS  
2

Number of LEDs	3
Number of Flash Patterns	5

See pg. 77 for Drill-Free Cab Mount Options

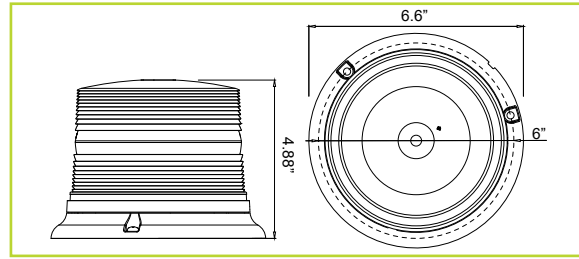

### SAE J845 Class 2 Beacon

Part No.	Color	Lead	Mounting	Amp	Wt. (lbs.)	Cat.
SL620ALP	Amber	10' ON/OFF Switch	Permanent, Pipe, and Magnetic	1.5	2.46	889 (N)

## Class 2 6.5" x 6.5" LED Beacon with Tall Lens

5-YEAR  
**W**  
12-24  
**VOLTS**  
SAE J848  
CLASS  
2

Number of LEDs	3
Number of Flash Patterns	5

See pg. 77 for Drill-Free Cab Mount Options

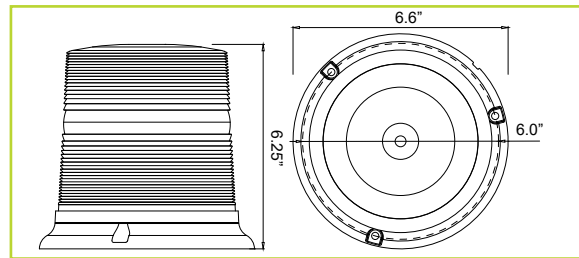

### SAE J845 Class 2 Beacon

Part No.	Color	Lead	Mounting	Amp	Wt. (lbs.)	Cat.
SL630A	Amber	10' ON/OFF Switch	Permanent, Pipe, and Magnetic	1.5	2.65	889 (N)

## Class 2 LED Micro Beacon

5-YEAR  
**W**  
12-24  
**VOLTS**  
**IP 67**  
SAE J848  
CLASS  
2

Number of LEDs	18
Flash	132 Flasher per Minute

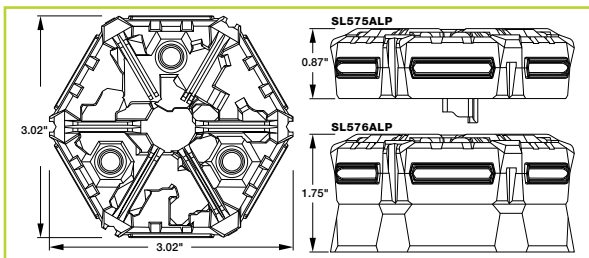

### SAE J845 Class 2 Beacon, Permanent Mount, Hard-wired

Part No.	Connection	Mounting	Amp	Wt. (lbs.)	Cat.
SL575ALP*	7" Blunt Cut	Permanent 5 mm Stud	1.3	0.19	889 (N)

### Accessories

Part No.	Description	Wt. (lbs.)	Cat.
3048064*	1.6" Riser Mount for SL575ALP	0.2	889 (N)

### SAE J845 Class 2 Beacon, Magnetic Mount, Auxiliary Power Plug

Part No.	Wiring	Mounting	Amp	Wt. (lbs.)	Cat.
SL576ALP*	12.5' Auxiliary Plug	Magnetic	1.3	0.6	889 (N)

# Beacon Lights

## Portable 5" x 4" LED Beacon



Number of LEDs	24
Flash	1

See pg. 77 for Drill-Free Cab Mount Options



SL475A



SL475R

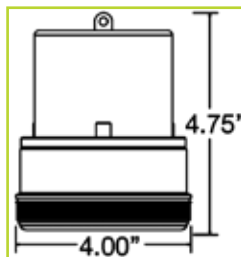

Part No.	Color	Power	Mounting	Wt. (lbs.)	Cat.
SL475A	Amber	(2) D Batteries	Magnetic	1.75	889 (N)

Automatic On/Off operation with light sensor or manual operation via selector switch.

Part No.	Color	Power	Mounting	Wt. (lbs.)	Cat.
SL475R	Red	(2) D Batteries	Magnetic	1.75	889 (N)

Automatic On/Off operation with light sensor or manual operation via selector switch.

### Accessories

Part No.	Description	Wt. (lbs.)	Cat.
3029961	Optional Galvanized Mounting Bracket	1.25	889 (N)

## Portable 5.5" x 4.5" LED Beacon



Number of LEDs	72
Number of Flash Patterns	1



See pg. 77 for Drill-Free Cab Mount Options

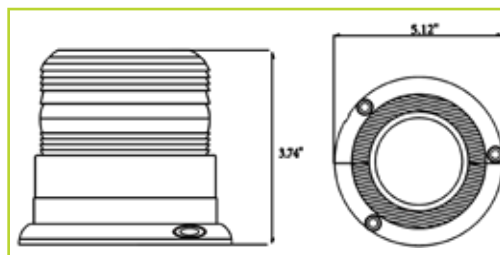

Part No.	Color	Power	Mounting	Amp	Wt. (lbs.)	Cat.
SL480A	Amber	(4) AA Batteries	Magnetic	0.2	1.29	889 (N)

Built-in power switch.

## 5" x 4" LED Beacon



Number of LEDs	40
Number of Flash Patterns	2



See pg. 77 for Drill-Free Cab Mount Options

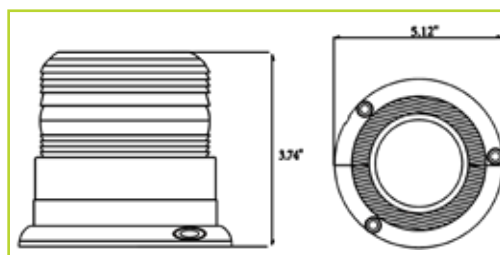

Part No.	Color	Lead	Mounting	Amp	Wt. (lbs.)	Cat.
SL501A	Amber	10' Auxiliary Cable	Magnetic and Permanent	0.6	1.28	889 (N)



## 6" x 5" Incandescent Beacon Strobe

1-YEAR  
**W**  
12-110  
**VOLTS**

Joules	1.7
Flash	1

See pg. 77 for Drill-Free Cab Mount Options

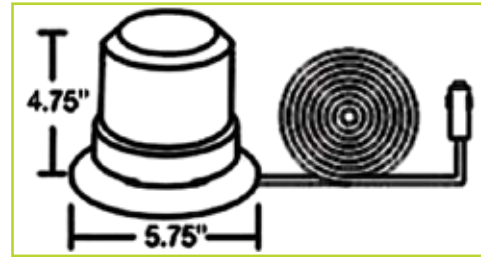

Part No.	Color	Lead	Mounting	Amp	Wt. (lbs.)	Cat.
SL650A	Amber	10' Auxiliary Cable	Magnetic and Permanent	0.3	1.5	889 (N)

## 6.5" x 5" Incandescent Beacon Strobe

1-YEAR  
**W**  
12-24  
**VOLTS**

Joules	8
Flash	1

See pg. 77 for Drill-Free Cab Mount Options

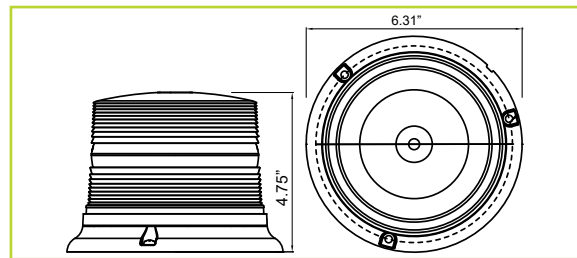
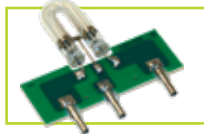

Part No.	Color	Lead	Mounting	Amp	Wt. (lbs.)	Cat.
SL640ALP	Amber	10" Blunt Cut	Permanent and Pipe	1.5	1.75	889 (N)

### Accessories

Part No.	Description	Wt. (lbs.)	Cat.
3016342	Replacement Bulb for SL660A	0.02	889 (N)

## 6.5" x 6.5" Incandescent Beacon Strobe

1-YEAR  
**W**  
12-24  
**VOLTS**

Joules	8
Flash	Dual Flash 80 FPM

See pg. 77 for Drill-Free Cab Mount Options

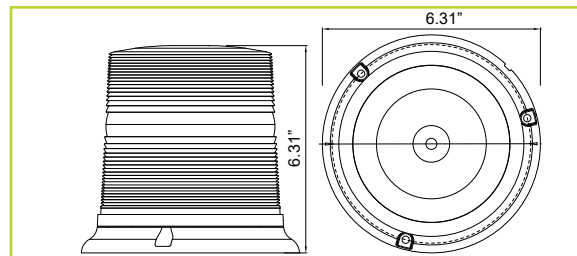
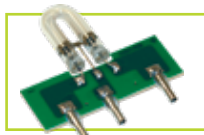

Part No.	Color	Lead	Mounting	Amp	Wt. (lbs.)	Cat.
SL660A	Amber	10" Blunt Cut	Permanent and Pipe	1.5	2.0	889 (N)

### Accessories

Part No.	Description	Wt. (lbs.)	Cat.
3016342	Replacement Bulb for SL660A	0.02	889 (N)



# Beacon Lights

## 5.5" Halogen Revolving Light

**1-YEAR**  
**W**  
**12-24**  
**VOLTS**

Flash	90 FPM
-------	--------

See pg. 77 for Drill-Free Cab Mount Options

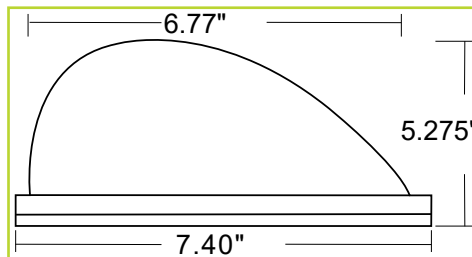

Part No.	Color	Lead	Mounting	Amp	Wt. (lbs.)	Cat.
 RL650A	Amber	10' Auxiliary Cable	Magnetic	1.5	1.5	889 (N)

## 5" x 4" Incandescent Beacon Strobe

**1-YEAR**  
**W**  
**12-24**  
**VOLTS**

Joules	1.7
Flash	2

See pg. 77 for Drill-Free Cab Mount Options

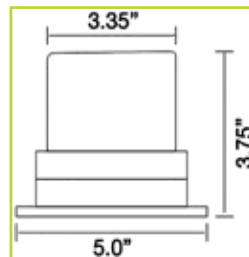

Part No.	Color	Lead	Mounting	Amp	Wt. (lbs.)	Cat.
 SL500A	Amber	10' Auxiliary Cable	Magnetic and Permanent	0.6	1.13	889 (N)



## Self-Leveling Beacon Mount



Part No.	Description	Wt. (lbs.)	Cat.
<b>B210880</b>	Self-Leveling Mounting Bracket, 3/16" Steel Plate with Black Powder Coating, 9"W (ID) x 7.625T (OD)	6.7	889 (N)

## Stainless Steel Mirror-Mounted Beacon Bracket



Part No.	Description	Wt. (lbs.)	Cat.
<b>8891001</b>	Beacon Mirror Mounting Bracket, Stainless Steel, 6.625" Diam x 4.875" T	1.4	889 (N)

**Includes U-Bolts.**

Bolt pattern fits most beacons up to 6.625" diameter.

## Beacon Brush Guard



Part No.	Description	Wt. (lbs.)	Cat.
<b>8891002</b>	Black Beacon Brush Guard 6.5" Diam x 6.5" T (See fit guide online at buyersproducts.com)	1.0	889 (N)

This guard will NOT work with the following beacon strobes: 8891020, B745229T, B745236T, RL650A, SL475A, SL475R, SL500A, SL501A, SL650A, SL660A, SL665A.

## Stainless Steel Beacon Mount Bracket



Part No.	Description	Wt. (lbs.)	Cat.
<b>8891003</b>	Stainless Steel Beacon Mount Bracket 10.5"H x 6.88"L x 6.63"W	1.94	889 (N)

## Self-Adhesive Magnetic Mount Pad for Aluminum Cabs

Construction	Carbon Steel
Finish	Black Powder-Coated
Size	3.5" L x 3.5"W
Mount	3M <sup>®</sup> Tape

Allows use of magnetic light mounts even on aluminum truck cabs



8895400 shown with SL695A beacon

Note: Allows use of magnetic light mounts even on aluminum truck cabs

Part No.	Description	Wt. (lbs.)	Cat.
<b>8895400</b>	Self-Adhesive Magnetic Mount Pad for Aluminum Cabs, Single	0.27	889 (N)
<b>8895404</b>	Self-Adhesive Magnetic Mount Pad for Aluminum Cabs, 4 Pack	1.02	889 (N)



DO





# T LIGHTS



# 0.75" Round Marker/Clearance Lights

## 1 LED Kits

	Number of LEDs	1
	Size	0.75"
	Connection	Hard Wired

Kit includes mount and grommet

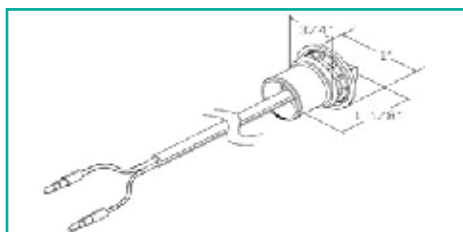

Part No.	Color	Lead	Amp	Std. Qty	Wt. (lbs.)	Cat.
5623413	Red	.180 Male Bullets	.021	10	0.03	562 (N)
5623423	Amber	.180 Male Bullets	.021	10	0.03	562 (N)
5627511	Red	.180 Male Bullets	.021	10	0.05	562 (N)
5627521	Amber	.180 Male Bullets	.021	10	0.05	562 (N)
5623414	Red	Stripped Leads	.021	10	0.02	562 (N)
5623424	Amber	Stripped Leads	.021	10	0.02	562 (N)
5627512	Red	Stripped Leads	.021	10	0.05	562 (N)
5627522	Amber	Stripped Leads	.021	10	0.02	562 (N)
5627532	Clear	Stripped Leads	.021	10	0.02	562 (N)

**Bulk.** Part number indicates single light only. Must order in multiples of 10.

### Accessories

Part No.	Description	Std. Qty	Wt. (lbs.)	Cat.
5627501	Black Grommet for .75" Round Marker Lights, for 1-LED Marker/Clearance Lights	25	0.05	562 (N)

**Bulk.** Part number indicates single item only. Must order in multiples of 25.

## 3 LED Kits

	Number of LEDs	3
	Size	0.75"
	Connection	Hard Wired

Kit includes mount and grommet

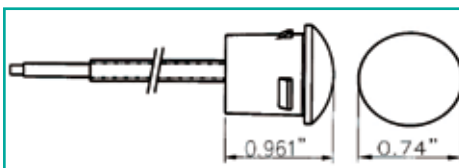

Part No.	Color	Lead	Amp	Std. Qty	Wt. (lbs.)	Cat.
5627513	Red	.180 Male Bullets	.038	10	0.05	562 (N)
5627514	Red	Stripped Leads	.038	10	0.05	562 (N)
5627517	Red	Stripped Leads	.038	1	0.05	562 (N)
5627523	Amber	.180 Male Bullets	.038	10	0.05	562 (N)
5627524	Amber	Stripped Leads	.038	10	0.05	562 (N)
5627527	Amber	Stripped Leads	.038	1	0.05	562 (N)

**Bulk.** Part number indicates single light only. 5627513, 5627514, 5627523, and 5627524 must be ordered in multiples of 10.

### Accessories

Part No.	Description	Std. Qty	Wt. (lbs.)	Cat.
5627503	Black Grommet for .75" Round Marker Lights, for 3-LED Marker/Clearance Lights	25	0.05	562 (N)

**Bulk.** Part number indicates single item only. Must order in multiples of 25.



## 2" Round Marker/Clearance Light with 1 LED



Number of LEDs	1
Size	2"
Connection	PL-10

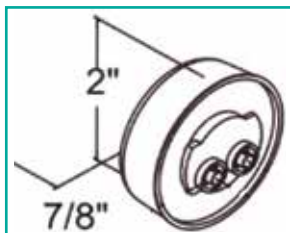

Part No.	Color	Mounting	Amp	Std. Qty	Wt. (lbs.)	Cat.
<b>5622101</b>	Red	Grommet (Included)	.050	1	0.18	562 (N)
<b>5622201</b>	Amber	Grommet (Included)	.050	1	0.18	562 (N)
<b>5622150</b>	Red	Grommet	.050	10	0.07	562 (N)
<b>5622250</b>	Amber	Grommet	.050	10	0.07	562 (N)

**Bulk.** Part number indicates single light only. 5622150 and 5622250 must be ordered in multiples of 10.

### Accessories

Part No.	Description	Std. Qty	Wt. (lbs.)	Cat.
<b>5622050</b>	Round, Open Back, Flush Mount	10	0.07	562 (N)
<b>5620250</b>	2-Pin In-Line Male PL-10 Plug with Stripped Power Wire and #10 Ring on Ground	25	0.03	562 (N)

**Bulk.** Part number indicates single item only. 5622050 must be ordered in multiples of 10 and 5620250 must be ordered in multiples of 25.

## 2" Round Marker/Clearance Light with 4 LEDs



Number of LEDs	4
Size	2"
Connection	PL-10

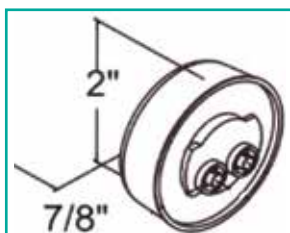

Part No.	Color	Mounting	Amp	Std. Qty	Wt. (lbs.)	Cat.
<b>5622102</b>	Red	Grommet (Included)	.039	1	0.18	562 (N)
<b>5622202</b>	Amber	Grommet (Included)	.039	1	0.18	562 (N)
<b>5622154</b>	Red	Grommet	.039	10	0.07	562 (N)
<b>5622254</b>	Amber	Grommet	.039	10	0.07	562 (N)

**Bulk.** Part number indicates single light only. 5622154 and 5622254 must be ordered in multiples of 10.

### Accessories

Part No.	Description	Std. Qty	Wt. (lbs.)	Cat.
<b>5622050</b>	Round, Open Back, Flush Mount	10	0.07	562 (N)
<b>5620250</b>	2-Pin In-Line Male PL-10 Plug with Stripped Power Wire and #10 Ring on Ground	25	0.03	562 (N)

**Bulk.** Part number indicates single item only. 5622050 must be ordered in multiples of 10 and 5620250 must be ordered in multiples of 25.

# 2.5" Round Marker/Clearance Lights

## 2.5" Round Marker/Clearance Light with 2 LEDs



Number of LEDs	2
Size	2.5"
Connection	PL-10

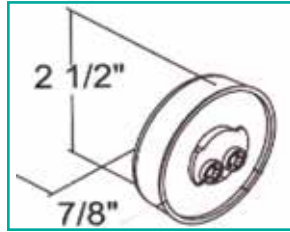

Part No.	Color	Mounting	Amp	Std. Qty	Wt. (lbs.)	Cat.
5622512	Red	Grommet	.044	10	0.11	562 (N)
5622522	Amber	Grommet	.044	10	0.11	562 (N)

**Bulk.** Part number indicates single light only. 5622512 and 5622522 must be ordered in multiples of 10.

### Accessories



Part No.	Description	Std. Qty	Wt. (lbs.)	Cat.
5622505	2.5" Round, Flush Mount, Semi-Open Back	10	0.11	562 (N)
5622506	2.5" Round, Flush Mount, Open Back	10	0.11	562 (N)
5620250	2-Pin In-Line Male PL-10 Plug with Stripped Power Wire and #10 Ring on Ground	25	0.03	562 (N)

**Bulk.** Part number indicates single item only. 5622505 and 5622506 must be ordered in multiples of 10. 5620250 must be ordered in multiples of 25.

## 2.5" Round Marker/Clearance Light with 4 LEDs



Number of LEDs	4
Size	2.5"
Connection	PL-10

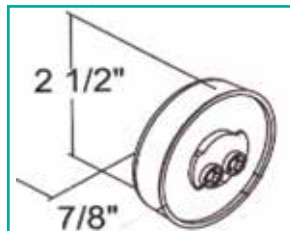

Part No.	Color	Mounting	Amp	Std. Qty	Wt. (lbs.)	Cat.
5622514	Red	Grommet (Included)	.032	1	0.11	562 (N)
5622524	Amber	Grommet (Included)	.032	1	0.11	562 (N)
5622550	Red	Grommet	.032	10	0.11	562 (N)
5622525	Amber	Grommet	.032	10	0.11	562 (N)

**Bulk.** Part number indicates single light only. 5622550 and 5622525 must be ordered in multiples of 10.

### Accessories



Part No.	Description	Std. Qty	Wt. (lbs.)	Cat.
5622505	2.5" Round, Flush Mount, Semi-Open Back	10	0.11	562 (N)
5622506	2.5" Round, Flush Mount, Open Back	10	0.11	562 (N)
5620250	2-Pin In-Line Male PL-10 Plug with Stripped Power Wire and #10 Ring on Ground	25	0.03	562 (N)

**Bulk.** Part number indicates single item only. 5622505 and 5622506 must be ordered in multiples of 10. 5620250 must be ordered in multiples of 25.



# 2.5" Round Marker/Clearance Lights

## 2.5" Round Marker/Clearance Light with 7 LEDs



Number of LEDs	7
Size	2.5"
Connection	PL-10

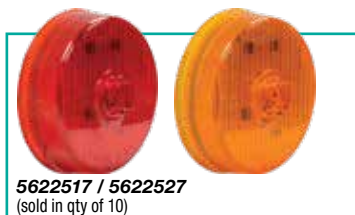
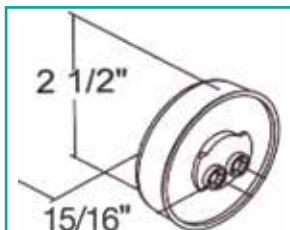

5622517 / 5622527  
(sold in qty of 10)

Part No.	Color	Mounting	Amp	Std. Qty	Wt. (lbs.)	Cat.
5622517	Red	Grommet	.19	10	0.11	562 (N)
5622527	Amber	Grommet	.19	10	0.11	562 (N)

**Bulk.** Part number indicates single light only. 5622517 and 5622527 must be ordered in multiples of 10.

### Accessories



5622505 / 5622506  
(sold in qty of 10)

5620250  
(sold in qty of 10)

Part No.	Description	Std. Qty	Wt. (lbs.)	Cat.
5622505	2.5" Round, Flush Mount, Semi-Open Back	10	0.11	562 (N)
5622506	2.5" Round, Flush Mount, Open Back	10	0.11	562 (N)
5620250	2-Pin In-Line Male PL-10 Plug with Stripped Power Wire and #10 Ring on Ground	25	0.03	562 (N)

**Bulk.** Part number indicates single item only. 5622505 and 5622506 must be ordered in multiples of 10. 5620250 must be ordered in multiples of 25.

## 2.5" Round Marker/Clearance Light with Reflex and 4 LEDs



Number of LEDs	4
Size	2.5"
Connection	PL-10

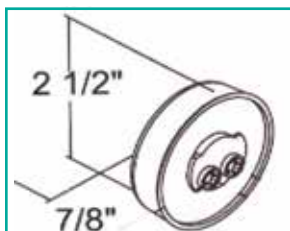

5622551 / 5622526  
Plug and grommet included

Part No.	Color	Mounting	Amp	Std. Qty	Wt. (lbs.)	Cat.
5622551	Red	Grommet	.030	10	0.11	562 (N)
5622526	Amber	Grommet	.033	10	0.11	562 (N)

**Bulk.** Part number indicates single light only. 5622551 and 5622526 must be ordered in multiples of 10.

### Accessories



5622505 / 5622506  
(sold in qty of 10)

5620250  
(sold in qty of 10)

Part No.	Description	Std. Qty	Wt. (lbs.)	Cat.
5622505	2.5" Round, Flush Mount, Semi-Open Back	10	0.11	562 (N)
5622506	2.5" Round, Flush Mount, Open Back	10	0.11	562 (N)
5620250	2-Pin In-Line Male PL-10 Plug with Stripped Power Wire and #10 Ring on Ground	25	0.03	562 (N)

**Bulk.** Part number indicates single item only. 5622505 and 5622506 must be ordered in multiples of 10. 5620250 must be ordered in multiples of 25.



# 2.5" and 2.875" Rectangular Marker/Clearance Lights

## 2.5" Surface Mount Marker Light with 3 LEDs



Number of LEDs	3
Size	2.5"
Connection	PL-10
Mounting	Surface Mount

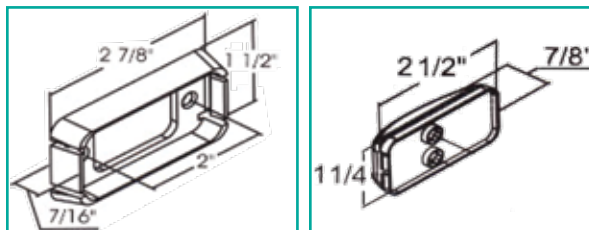

5622103 / 5622203  
Plug and mounting bracket included



5622104 / 5622204 / 5622304  
Light only (sold in qty of 10)



5622205  
(sold in qty of 10)



5620250  
(sold in qty of 10)

Part No.	Color	Amp	Std. Qty	Wt. (lbs.)	Cat.
5622103	Red	.042	1	0.05	562 (N)
5622203	Amber	.042	1	0.05	562 (N)
5622104	Red	.042	10	0.05	562 (N)
5622204	Amber	.042	10	0.05	562 (N)
5622304	Clear	.042	10	0.05	562 (N)

**Bulk.** Part number indicates single light only. 5622104, 5622204 and 5622304 must be ordered in multiples of 10.

### Accessories

Part No.	Description	Std. Qty	Wt. (lbs.)	Cat.
5622205	2.5" Flush Mount, Open Back Grommet for use with 5622104, 5622204, 5622304	10	0.11	562 (N)
5620250	2-Pin In-Line Male PL-10 Plug with Stripped Power Wire and #10 Ring on Ground	25	0.03	562 (N)

**Bulk.** Part number indicates single item only. 5622205 must be ordered in multiples of 10 and 5620250 must be ordered in multiples of 25.

## 2.875" Rectangular Marker/Clearance Light with Reflex and 6 LEDs



Number of LEDs	6
Size	2.875"
Connection	Hard Wired with Stripped Lead and Ring Terminal
Mounting	Stud

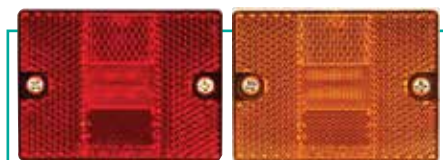
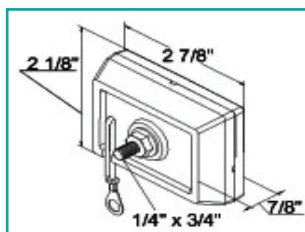

5622716 / 5622726  
Includes ground wire (sold in qty of 10)

Part No.	Color	Amp	Std. Qty	Wt. (lbs.)	Cat.
5622716	Red	.033	10	0.14	562 (N)
5622726	Amber	.033	10	0.14	562 (N)

**Bulk.** Part number indicates single light only. 5622716 and 5622726 must be ordered in multiples of 10.



# 3.125" and 3.75" Rectangular Marker/Clearance Lights

## 3.125" Rectangular Marker/Clearance Light with Reflex and 2 LEDs



Number of LEDs	2
Size	3.125"
Connection	PL-10
Mounting	Surface Mount

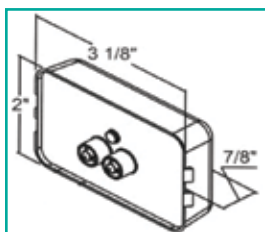

5623112 / 5623122  
Plug and grommet included

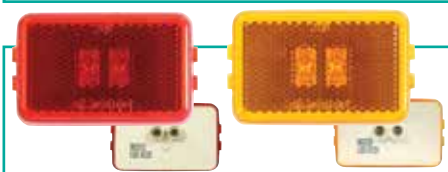

5622113 / 5623123  
Light only (sold in qty of 10)



5623050  
(sold in qty of 10)



5620250  
(sold in qty of 10)

Part No.	Color	Amp	Std. Qty	Wt. (lbs.)	Cat.
5623112	Red	.044	1	0.05	562 (N)
5623122	Amber	.044	1	0.05	562 (N)
5623113	Red	.044	10	0.08	562 (N)
5623123	Amber	.044	10	0.08	562 (N)

**Bulk.** Part number indicates single light only. 5622550 and 5622525 must be ordered in multiples of 10.

### Accessories

Part No.	Description	Std. Qty	Wt. (lbs.)	Cat.
5623050	3.125" Recessed Mount Black Grommet for use with 5623113, 5623123	10	0.05	562 (N)
5620250	2-Pin In-Line Male PL-10 Plug with Stripped Power Wire and #10 Ring on Ground	25	0.03	562 (N)

**Bulk.** Part number indicates single item only. 5623050 must be ordered in multiples of 10 and 5620250 must be ordered in multiples of 25.

## 3.75" Rectangular Marker/Clearance Light with 2 LEDs



Number of LEDs	2
Connection	Male Barrel Terminals
Mounting	Surface Mount

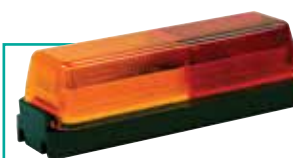
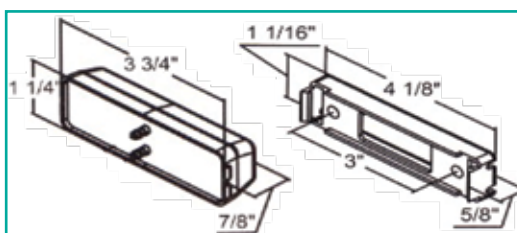

5623711  
Plug and mounting bracket included (sold in qty of 10)



5623712  
Light only (sold in qty of 10)



5623812 / 5623822  
Light only (sold in qty of 10)

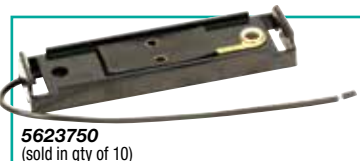

5623750  
(sold in qty of 10)

Part No.	Size	Color	Amp	Std. Qty	Wt. (lbs.)	Cat.
5623711	3.75"	Amber/Red	.085	10	0.05	562 (N)
5623712	3.75"	Amber/Red	.085	10	0.05	562 (N)
5623812	3.875"	Red	.060	10	0.04	562 (N)
5623822	3.875"	Amber	.060	10	0.04	562 (N)

**Bulk.** Part number indicates single light only. 5623711, 5623712, 5623812 and 5623822 must be ordered in multiples of 10.

### Accessories

Part No.	Description	Std. Qty	Wt. (lbs.)	Cat.
5623750	3.75" Black Mounting Bracket Includes Stripped Lead for 5623712	1	0.05	562 (N)

# ID Lights & Slimline Stop, Turn & Tail Light

## 0.75" ID Light with 9 LEDs



Number of LEDs	9
Size	0.75"
Connection	Hard Wired with .180 Male Bullets
Mounting	Grommet

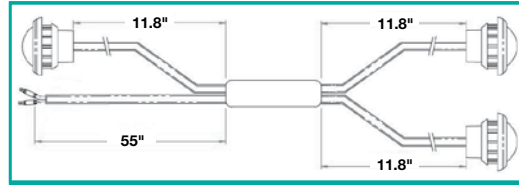

Part No.	Color	Amp	Std. Qty	Wt. (lbs.)	Cat.
5627533	Red	.113	1	0.50	562 (N)

## Stainless Steel ID Bar Light with 9 LEDs



Number of LEDs	9
Size	14"
Connection	Hard Wired with Stripped Lead and Ring Terminal
Mounting	Surface

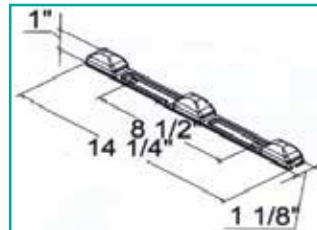

Part No.	Color	Amp	Std. Qty	Wt. (lbs.)	Cat.
5621720	Red	.147	1	0.55	562 (N)

## 17" Polycarbonate ID Bar Light with 9 LEDs



Number of LEDs	9
Size	17"
Connection	Hard Wired with Stripped Lead and Ring Terminal
Mounting	Surface

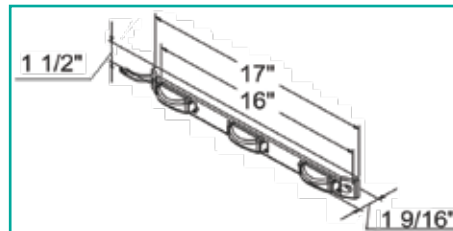

Part No.	Color	Amp	Std. Qty	Wt. (lbs.)	Cat.
5621719	Red	.119	1	0.65	562 (N)

## 17" Slimline Stop/Turn/Tail Light with 11 LEDs



Number of LEDs	11
Size	17"
Connection	Hard Wired with Stripped Lead and Ring Terminal
Mounting	Surface

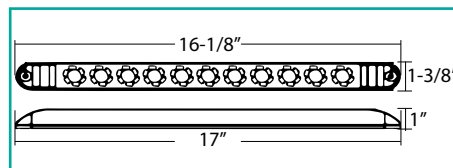

Part No.	Color	Amp	Std. Qty	Wt. (lbs.)	Cat.
5621711	Red	.162	10	0.41	562 (N)

**Bulk.** Part number indicates single item only. Must order in multiples of 10.



## 4" Round Stop/Turn/Tail Light with 1 LED



Number of LEDs	1
Size	4"
Connection	PL-3

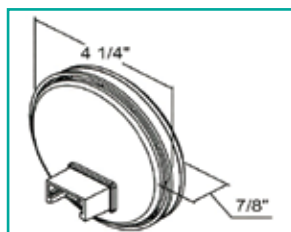

Part No.	Color	Mounting	Amp	Std. Qty	Wt. (lbs.)	Cat.
5624101	Red	Grommet	.150	10	0.23	562 (N)

**Bulk.** Part number indicates single item only. Must order in multiples of 10.

### Accessories

Part No.	Description	Std. Qty	Wt. (lbs.)	Cat.
5624050	Replacement Black Grommet	10	0.15	562 (N)
5620350	3-Pin Right Angle Male PL-3 Plug with Stripped Leads and #10 Ring on Ground	25	0.03	562 (N)
5620355	3-Wire, 3-Pin Straight Male PL-3 Plug with Stripped Leads and #10 Ring on Ground	25	0.05	562 (N)

**Bulk.** Part number indicates single item only. 5624050 must be ordered in multiples of 10. 5620350 and 5620355 must be ordered in multiples of 25.

## 4" Round Stop/Turn/Tail Light with 7 LEDs



Number of LEDs	7
Size	4"
Connection	PL-3

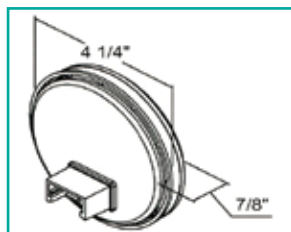

Part No.	Color	Mounting	Amp	Std. Qty	Wt. (lbs.)	Cat.
5624157	Red	Grommet (Included)	.150	1	0.23	562 (N)
5624156	Red	Grommet	.150	10	0.23	562 (N)

**Bulk.** Part number indicates single item only. Must order in multiples of 10.

### Accessories

Part No.	Description	Std. Qty	Wt. (lbs.)	Cat.
5624050	Replacement Black Grommet	10	0.15	562 (N)
5620350	3-Pin Right Angle Male PL-3 Plug with Stripped Leads and #10 Ring on Ground	25	0.03	562 (N)
5620355	3-Wire, 3-Pin Straight Male PL-3 Plug with Stripped Leads and #10 Ring on Ground	25	0.05	562 (N)

**Bulk.** Part number indicates single item only. 5624050 must be ordered in multiples of 10. 5620350 and 5620355 must be ordered in multiples of 25.



# 4" Round Stop, Turn & Tail Lights

## 4" Round Stop/Turn/Tail Light with 10 LEDs

	Number of LEDs	10
	Size	4"
	Connection	PL-3

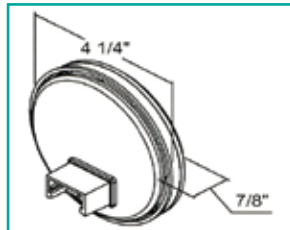

Part No.	Color	Mounting	Connection	Amp	Std. Qty	Wt. (lbs.)	Cat.
5624110	Red	Grommet (Included)	PL-3	.113	1	0.70	562 (N)
5624150	Red	Grommet	PL-3	.113	10	0.36	562 (N)
5624151	Red	Grommet	AMP-Style	.105	10	0.34	562 (N)

**Bulk.** Part number indicates single light only. 5624150 and 5624151 must be ordered in multiples of 10.

### Accessories

Part No.	Description	Std. Qty	Wt. (lbs.)	Cat.
5624050	Replacement Black Grommet	10	0.15	562 (N)
5620350	3-Pin Right Angle Male PL-3 Plug with Stripped Leads and #10 Ring on Ground	25	0.03	562 (N)
5620355	3-Wire, 3-Pin Straight Male PL-3 Plug with Stripped Leads and #10 Ring on Ground	25	0.05	562 (N)
5620352	3-Wire AMP-Style Plug, with Stripped Leads and #10 Ring on Ground	25	0.03	562 (N)

**Bulk.** Part number indicates single item only. 5624050 must be ordered in multiples of 10. 5620350, 5620355 and 5620352 must be ordered in multiples of 25.

## 4" Round Stop/Turn/Tail Light with 18 LEDs

	Number of LEDs	18
	Size	4"
	Connection	PL-3

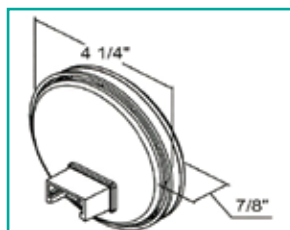

Part No.	Color	Mounting	Amp	Std. Qty	Wt. (lbs.)	Cat.
5624118	Red	Grommet (Included)	.208	1	0.80	562 (N)
5624119	Red	Grommet	.208	10	0.40	562 (N)

**Bulk.** Part number indicates single light only. 5624119 must be ordered in multiples of 10.

### Accessories

Part No.	Description	Std. Qty	Wt. (lbs.)	Cat.
5624050	Replacement Black Grommet	10	0.15	562 (N)
5620350	3-Pin Right Angle Male PL-3 Plug with Stripped Leads and #10 Ring on Ground	25	0.03	562 (N)
5620355	3-Wire, 3-Pin Straight Male PL-3 Plug with Stripped Leads and #10 Ring on Ground	25	0.05	562 (N)

**Bulk.** Part number indicates single item only. 5624050 must be ordered in multiples of 10. 5620350 and 5620355 must be ordered in multiples of 25.



# 4" Round Stop, Turn, Tail and Backup Lights

## 4" Round Stop/Turn/Tail/Backup Light with 12 LEDs

LIMITED LIFETIME WARRANTY  
12 VOLTS  
IP 67

Number of LEDs	12
Size	4"
Connection	PL-3 and PL-2

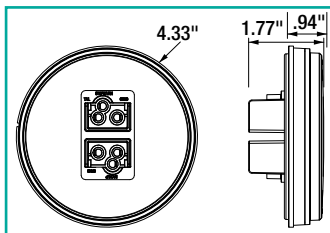

Part No.	Color	Mounting	Amp	Std. Qty	Wt. (lbs.)	Cat.
5624131	Red/Clear	Grommet (Included)	.80	1	0.23	562 (N)
5624130	Red/Clear	Grommet	.80	10	0.23	562 (N)

**Bulk.** Part number indicates single light only. 5624130 must be ordered in multiples of 10.

### Accessories

Part No.	Description	Std. Qty	Wt. (lbs.)	Cat.
5624050	Replacement Black Grommet	10	0.15	562 (N)
5620251	2-Pin Right Angle Male Plug with Stripped Power Wire and #10 Ring on Ground	25	0.03	562 (N)
5620350	3-Pin Right Angle Male PL-3 Plug with Stripped Leads and #10 Ring on Ground	25	0.03	562 (N)

**Bulk.** Part number indicates single item only. 5624050 must be ordered in multiples of 10. 5620251 and 5620350 must be ordered in multiples of 25.

## 4" Round Stop/Turn/Tail/Backup Light with 13 LEDs

LIMITED LIFETIME WARRANTY  
12 VOLTS  
IP 69

Number of LEDs	13
Size	4"
Connection	PL-3 and PL-2

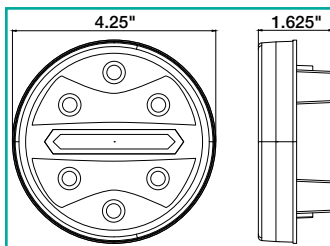

Part No.	Color	Mounting	Amp	Std. Qty	Wt. (lbs.)	Cat.
5624132*	Red/Clear	Grommet	0.46	10	0.50	562 (N)

Featuring "Light Stripe" LED light tube technology.  
**Bulk.** Part number indicates single light only. Must order in multiples of 10.

### Accessories

Part No.	Description	Std. Qty	Wt. (lbs.)	Cat.
5624050	Black Grommet for use with 5624132	10	0.15	562 (N)
5620251	2-Pin Right Angle Male Plug with Stripped Power Wire and #10 Ring on Ground	25	0.03	562 (N)
5620350	3-Pin Right Angle Male PL-3 Plug with Stripped Leads and #10 Ring on Ground	25	0.03	562 (N)

**Bulk.** Part number indicates single item only. 5624050 must be ordered in multiples of 10. 5620251 and 5620350 must be ordered in multiples of 25.

# 6" Oval Stop, Turn & Tail Lights

## 6" Oval Stop/Turn/Tail Light with 1 LED



Number of LEDs	1
Size	6"
Connection	PL-3

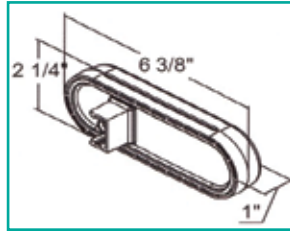

Part No.	Color	Mounting	Amp	Std. Qty	Wt. (lbs.)	Cat.
5626101	Red	Grommet	.150	10	0.23	562 (N)

**Bulk.** Part number indicates single item only. Must order in multiples of 10.

### Accessories

Part No.	Description	Std. Qty	Wt. (lbs.)	Cat.
5626050	Replacement Black Grommet	10	0.18	562 (N)
5620350	3-Pin Right Angle Male PL-3 Plug with Stripped Leads and #10 Ring on Ground	25	0.03	562 (N)
5620355	3-Wire, 3-Pin Straight Male PL-3 Plug with Stripped Leads and #10 Ring on Ground	25	0.05	562 (N)

**Bulk.** Part number indicates single item only. 5626050 must be ordered in multiples of 10. 5620350 and 5620355 must be ordered in multiples of 25.



## 6" Oval Stop/Turn/Tail Light with 6 LEDs



Number of LEDs	6
Size	6"
Connection	PL-3

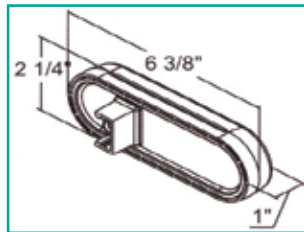

Part No.	Color	Mounting	Amp	Std. Qty	Wt. (lbs.)	Cat.
5626157	Red	Grommet (Included)	.150	1	0.23	562 (N)

5626156	Red	Grommet	.150	10	0.23	562 (N)
---------	-----	---------	------	----	------	---------

**Bulk.** Part number indicates single light only. 5624130 must be ordered in multiples of 10.



### Accessories

Part No.	Description	Std. Qty	Wt. (lbs.)	Cat.
5626050	Replacement Black Grommet	10	0.18	562 (N)
5620350	3-Pin Right Angle Male PL-3 Plug with Stripped Leads and #10 Ring on Ground	25	0.03	562 (N)
5620355	3-Wire, 3-Pin Straight Male PL-3 Plug with Stripped Leads and #10 Ring on Ground	25	0.05	562 (N)

**Bulk.** Part number indicates single item only. 5626050 must be ordered in multiples of 10. 5620350 and 5620355 must be ordered in multiples of 25.

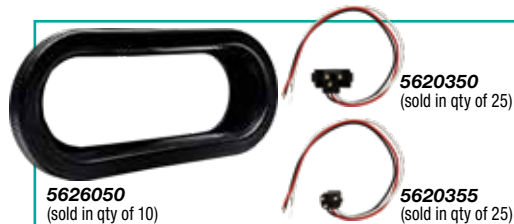

## 6" Oval Stop/Turn/Tail Light with 10 LEDs



Number of LEDs	10
Size	6"

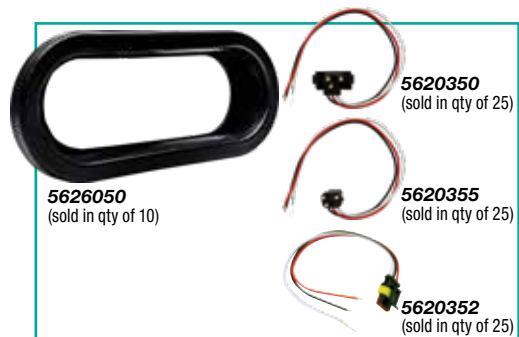
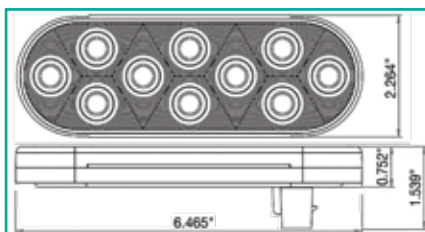

Part No.	Color	Mounting	Connection	Amp	Std. Qty	Wt. (lbs.)	Cat.
5626510	Red	Grommet (Included)	PL-3	.129	1	0.50	562 (N)
5626550	Red	Grommet	PL-3	.129	10	0.36	562 (N)
5626551	Red	Grommet	AMP-Style	.112	10	0.29	562 (N)
5626553	Clear Lens Red LEDs	Grommet	PL-3	.129	10	0.36	562 (N)

**Bulk.** Part number indicates single light only. 5626550, 5626551 and 5626553 must be ordered in multiples of 10.

### Accessories

Part No.	Description	Std. Qty	Wt. (lbs.)	Cat.
5626050	Replacement Black Grommet	10	0.18	562 (N)
5620350	3-Pin Right Angle Male PL-3 Plug with Stripped Leads and #10 Ring on Ground	25	0.03	562 (N)
5620355	3-Wire, 3-Pin Straight Male PL-3 Plug with Stripped Leads and #10 Ring on Ground	25	0.05	562 (N)
5620352	3-Wire AMP-Style Plug, with Stripped Leads and #10 Ring on Ground	25	0.03	562 (N)

**Bulk.** Part number indicates single item only. 5626050 must be ordered in multiples of 10. 5620350, 5620355 and 5620352 must be ordered in multiples of 25.

## 6" Hardwired Surface Mount Oval Stop/Turn/Tail Light Kit with 10 LEDs



Number of LEDs	10
Size	6"
Connection	Hard Wired with Stripped Leads & Ring Terminal

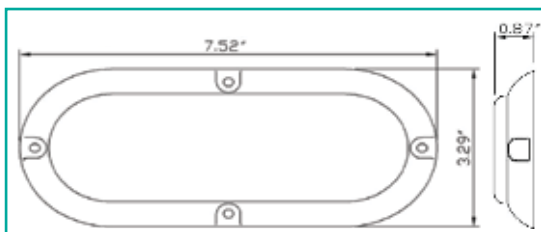

Part No.	Color	Mounting	Amp	Std. Qty	Wt. (lbs.)	Cat.
5626552	Red	Surface	.106	1	0.34	562 (N)



# 6" Oval Stop, Turn, Tail and Backup Lights

## 6" Oval Stop/Turn/Tail/Backup Light with 14 LEDs

LIMITED LIFETIME WARRANTY  
12 VOLTS  
IP 67

Number of LEDs	14
Size	6"
Connection	PL-3 and PL-2

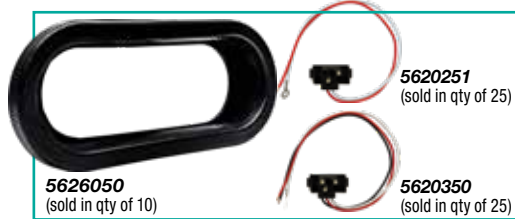
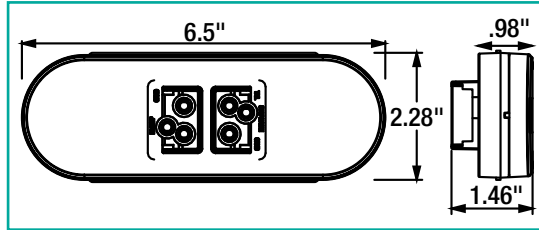

Part No.	Color	Mounting	Amp	Std. Qty	Wt. (lbs.)	Cat.
<b>5626131</b>	Red/Clear	Grommet (Included)	.80	1	0.3	562 (N)
<b>5626130</b>	Red/Clear	Grommet	.80	10	0.3	562 (N)

**Bulk.** Part number indicates single light only. 5626130 must be ordered in multiples of 10.

### Accessories

Part No.	Description	Std. Qty	Wt. (lbs.)	Cat.
<b>5626050</b>	Black Grommet for use with 5626132	10	0.18	562 (N)
<b>5620251</b>	2-Pin Right Angle Male Plug with Stripped Power Lead and #10 Ring on Ground	25	0.03	562 (N)
<b>5620350</b>	3-Pin Right Angle Male Plug with Stripped Power Leads and #10 Ring on Ground	25	0.05	562 (N)

**Bulk.** Part number indicates single item only. 5626050 must be ordered in multiples of 10. 5620251 and 5620350 must be ordered in multiples of 25.

## 6" Oval Stop/Turn/Tail/Backup Light with 17 LEDs

LIMITED LIFETIME WARRANTY  
12 VOLTS  
IP 69

Number of LEDs	17
Size	6"
Connection	PL-3 and PL-2
Compliance Family	FMVSS 108

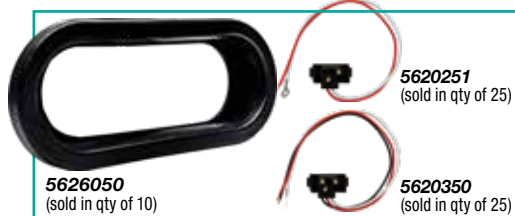
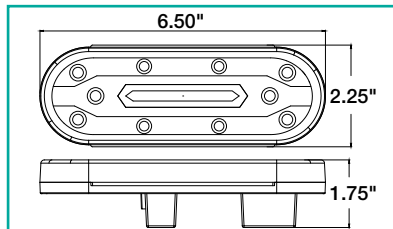

Part No.	Color	Mounting	Amp	Std. Qty	Wt. (lbs.)	Cat.
<b>5626132*</b>	Red/Clear	Grommet	.46	10	0.50	562 (N)

Featuring "Light Stripe" LED light tube technology.  
**Bulk.** Part number indicates single light only. Must order in multiples of 10.

### Accessories

Part No.	Description	Std. Qty	Wt. (lbs.)	Cat.
<b>5626050</b>	Black Grommet for use with 5626132	10	0.18	562 (N)
<b>5620251</b>	2-Pin Right Angle Male Plug with Stripped Power Lead and #10 Ring on Ground	25	0.03	562 (N)
<b>5620350</b>	3-Pin Right Angle Male Plug with Stripped Power Leads and #10 Ring on Ground	25	0.05	562 (N)

**Bulk.** Part number indicates single item only. 5626050 must be ordered in multiples of 10. 5620251 and 5620350 must be ordered in multiples of 25.



## 6" Oval Stop/Turn/Tail Light with 20 LEDs



Number of LEDs	20
Size	6"
Connection	PL-3

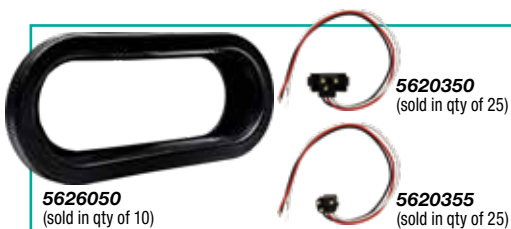
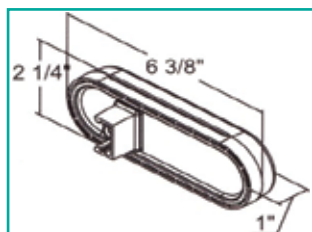

Part No.	Color	Mounting	Amp	Std. Qty	Wt. (lbs.)	Cat.
<b>5626520</b>	Red	Grommet(Included)	.162	1	0.83	562 (N)
<b>5626521</b>	Red	Grommet	.162	10	0.31	562 (N)

**Bulk.** Part number indicates single light only. 5626130 must be ordered in multiples of 10.

### Accessories

Part No.	Description	Std. Qty	Wt. (lbs.)	Cat.
<b>5626050</b>	Replacement Black Grommet	10	0.18	562 (N)
<b>5620350</b>	3-Pin Right Angle Male PL-3 Plug with Stripped Leads and #10 Ring on Ground	25	0.03	562 (N)
<b>5620355</b>	3-Wire, 3-Pin Straight Male PL-3 Plug with Stripped Leads and #10 Ring on Ground	25	0.05	562 (N)

**Bulk.** Part number indicates single item only. 5626050 must be ordered in multiples of 10. 5620350 and 5620355 must be ordered in multiples of 25.

## 5.33" Rectangular Stop/Turn/Tail Kit with 15 LEDs



Number of LEDs	15
Size	5.33"
Connection	PL-3

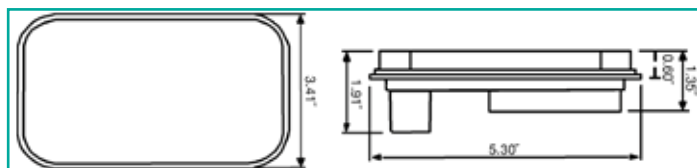

Part No.	Color	Mounting	Amp	Std. Qty	Wt. (lbs.)	Cat.
<b>5625115</b>	Red	Grommet (Included)	.188	1	0.65	562 (N)

# 5" Box-Style Stop, Turn, Tail Lights

## 5" Box-Style LED Stop/Turn/Tail Light (For Trailers Under 80" Wide)



Size	5"
Connection	Hard Wired with Stripped Leads
Mounting	Stud

Grounds through mounting stud.  
Red polycarbonate colored lens and built-in reflector lens.

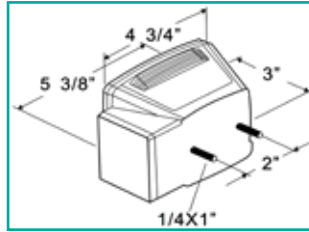

5625111



5625111  
Back and side shown



5625117



5625117  
Shown with built-in license plate light

Part No.	LEDs	Color	Style	Amp	Std. Qty	Wt. (lbs.)	Cat.
5625111	11	Red	Passenger Side	.1	1	0.66	562 (N)
5625117	17	Red	Driver Side	.1	1	0.70	562 (N)

## 5.75" Box Style Stop/Turn/Tail and Back-Up with Reflex



Size	5"
Connection	Hard Wired with Stripped Leads
Mounting	Stud

Includes ground wire.

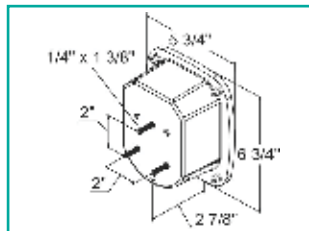

5626734



5626738  
Shown with built-in license plate light

Part No.	LEDs	Color	Style	Amp	Std. Qty	Wt. (lbs.)	Cat.
5626734	34	Red	Passenger Side	.091	1	1.24	562 (N)
5626738	38	Red	Driver Side	.091	1	1.24	562 (N)

5626738 includes license light.



5626700

### Accessories

Part No.	Description	Std. Qty	Wt. (lbs.)	Cat.
5626700	License Plate Bracket	1	0.12	562 (N)



## 4" Round Turn and Park Light with 1 LED



Number of LEDs	1
Size	4"
Connection	PL-3

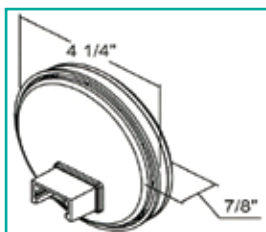

Part No.	Color	Mounting	Amp	Std. Qty	Wt. (lbs.)	Cat.
<b>5624201</b>	Amber	Grommet	.150	10	0.70	562 (N)

**Bulk.** Part number indicates single item only. Must order in multiples of 10.

### Accessories

Part No.	Description	Std. Qty	Wt. (lbs.)	Cat.
<b>5624050</b>	Replacement Black Grommet	10	0.15	562 (N)
<b>5620350</b>	3-Pin Right Angle Male PL-3 Plug with Stripped Leads and #10 Ring on Ground	25	0.03	562 (N)

**Bulk.** Part number indicates single item only. 5624050 must be ordered in multiples of 10. 5620350 must be ordered in multiples of 25.

## 4" Round Turn and Park Light with 7 LEDs



Number of LEDs	7
Size	4"
Connection	PL-3

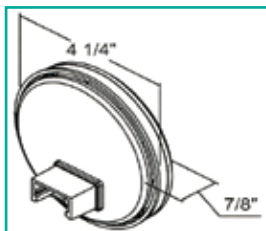

Part No.	Color	Mounting	Amp	Std. Qty	Wt. (lbs.)	Cat.
<b>5624207</b>	Amber	Grommet	.150	10	0.23	562 (N)

**Bulk.** Part number indicates single item only. Must order in multiples of 10.

### Accessories

Part No.	Description	Std. Qty	Wt. (lbs.)	Cat.
<b>5624050</b>	Replacement Black Grommet	10	0.15	562 (N)
<b>5620251</b>	2-Pin Right Angle Male Plug with Stripped Power Wire and #10 Ring on Ground	25	0.03	562 (N)

**Bulk.** Part number indicates single item only. 5624050 must be ordered in multiples of 10. 5620251 must be ordered in multiples of 25.



# 4" Round and 6" Oval Turn Signal Lights

## 4" Round Turn Signal Light with 10 LEDs



Number of LEDs	10
Size	4"

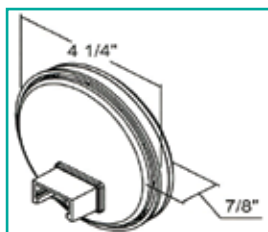
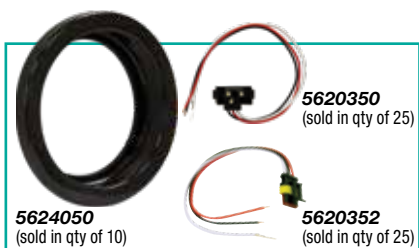

Part No.	Color	Mounting	Connection	Amp	Std. Qty	Wt. (lbs.)	Cat.
5624210	Amber	Grommet (Included)	PL-3	.221	1	0.70	562 (N)
5624211*	Amber	Grommet	PL-3	.221	10	0.36	562 (N)
5624251	Amber	Grommet	AMP-Style	.221	10	0.70	562 (N)

**Bulk.** Part number indicates single light only. 5624211 and 5624251 must be ordered in multiples of 10.

### Accessories

Part No.	Description	Std. Qty	Wt. (lbs.)	Cat.
5624050	Replacement Black Grommet	10	0.15	562 (N)
5620350	3-Pin Right Angle Male PL-3 Plug with Stripped Leads and #10 Ring on Ground for use with 5624211	25	0.03	562 (N)
5620352	3-Wire AMP-Style Plug, with Stripped Leads and #10 Ring on Ground for use with 5624251	10	0.03	562 (N)

**Bulk.** Part number indicates single item only. 5624050 and 5620352 must be ordered in multiples of 10. 5620350 must be ordered in multiples of 25.

## 6" Oval Turn and Park Signal Light with 1 LED



Number of LEDs	1
Size	6"
Connection	PL-3

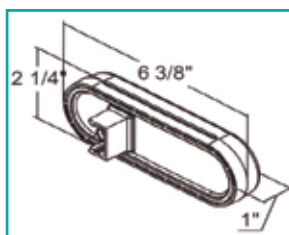
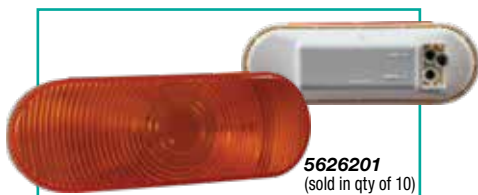

Part No.	Color	Mounting	Amp	Std. Qty	Wt. (lbs.)	Cat.
5626201	Amber	Grommet	.150	10	0.71	562 (N)

**Bulk.** Part number indicates single item only. Must order in multiples of 10.

### Accessories

Part No.	Description	Std. Qty	Wt. (lbs.)	Cat.
5626050	Replacement Black Grommet	10	0.18	562 (N)
5620350	3-Pin Right Angle Male PL-3 Plug with Stripped Leads and #10 Ring on Ground	25	0.03	562 (N)

**Bulk.** Part number indicates single item only. 5626050 must be ordered in multiples of 10. 5620350 must be ordered in multiples of 25.



## 6" Oval Turn and Park Signal Light with 6 LEDs



Number of LEDs	6
Size	6"
Connection	PL-3

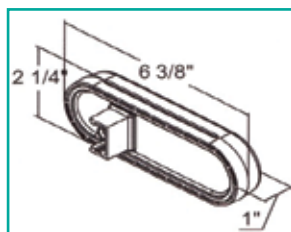

Part No.	Color	Mounting	Amp	Std. Qty	Wt. (lbs.)	Cat.
<b>5626206</b>	Amber	Grommet	.150	10	0.23	562 (N)

**Bulk.** Part number indicates single item only. Must order in multiples of 10.

### Accessories

Part No.	Description	Std. Qty	Wt. (lbs.)	Cat.
<b>5626050</b>	Replacement Black Grommet	10	0.18	562 (N)
<b>5620251</b>	2-Pin Right Angle Male Plug with Stripped Power Wire and #10 Ring on Ground	25	0.03	562 (N)

**Bulk.** Part number indicates single item only. 5626050 must be ordered in multiples of 10. 5620251 must be ordered in multiples of 25.

## 6" Oval Turn Signal Light with 10 LEDs



Number of LEDs	10
Size	6"
Connection	PL-3

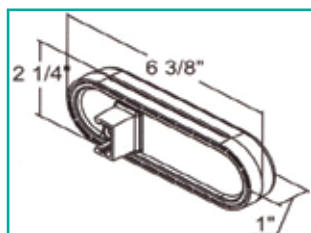

Part No.	Color	Mounting	Amp	Std. Qty	Wt. (lbs.)	Cat.
<b>5626210</b>	Amber	Grommet (Included)	.224	1	0.71	562 (N)
<b>5626211</b>	Amber	Grommet	.224	10	0.31	562 (N)

**Bulk.** Part number indicates single light only. 5626211 must be ordered in multiples of 10.

### Accessories

Part No.	Description	Std. Qty	Wt. (lbs.)	Cat.
<b>5626050</b>	Replacement Black Grommet	10	0.18	562 (N)
<b>5620350</b>	3-Pin Right Angle Male PL-3 Plug with Stripped Leads and #10 Ring on Ground	25	0.03	562 (N)

**Bulk.** Part number indicates single item only. 5626050 must be ordered in multiples of 10. 5620350 must be ordered in multiples of 25.

# 6" Oval Turn Signal Lights

## 6" Midship Turn Signal and Side Marker with Reflex and 9 LEDs



Number of LEDs	9
Size	6"
Connection	PL-3

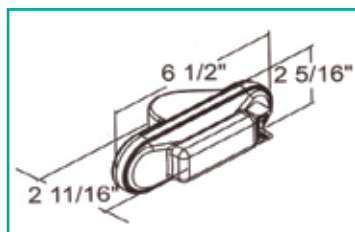

**5626209**  
Plug and grommet included



**5626208**  
Light only (sold in qty of 10)



**5626050**  
(sold in qty of 10)

**5620350**  
(sold in qty of 25)

Part No.	Color	Mounting	Amp	Std. Qty	Wt. (lbs.)	Cat.
<b>5626209</b>	Amber	Grommet (Included)	.114	1	0.30	562 (N)
<b>5626208</b>	Amber	Grommet	.114	10	0.30	562 (N)

**Bulk.** Part number indicates single light only. 5626208 must be ordered in multiples of 10.

### Accessories

Part No.	Description	Std. Qty	Wt. (lbs.)	Cat.
<b>5626050</b>	Replacement Black Grommet	10	0.18	562 (N)
<b>5620350</b>	3-Pin Right Angle Male PL-3 Plug with Stripped Leads and #10 Ring on Ground	25	0.03	562 (N)

**Bulk.** Part number indicates single light only. 5626050 must be ordered in multiples of 10. 5620350 must be ordered in multiples of 25.

## 5.33" Rectangular Turn Signal Light Kit with 15 LEDs



Number of LEDs	15
Size	5.33"
Connection	PL-3

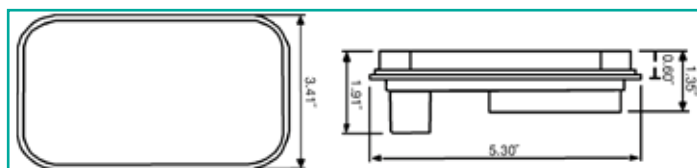

**5625115**  
Plug and grommet included

Part No.	Color	Mounting	Amp	Std. Qty	Wt. (lbs.)	Cat.
<b>5625215</b>	Amber	Grommet (Included)	.245	1	0.71	562 (N)



## 4" Round Stop/Turn/Tail Light with 7 LED



Number of LEDs	7
Size	4"
Connection	STD PL-2

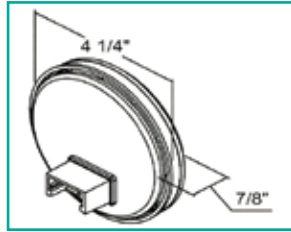

Part No.	Color	Mounting	Amp	Std. Qty	Wt. (lbs.)	Cat.
<b>5624357</b>	Clear	Grommet (Included)	.150	10	0.23	562 (N)
<b>5624356</b>	Clear	Grommet	.150	10	0.23	562 (N)

**Bulk.** Part number indicates single item only. Must order in multiples of 10.

### Accessories

Part No.	Description	Std. Qty	Wt. (lbs.)	Cat.
<b>5624050</b>	Replacement Black Grommet	10	0.15	562 (N)
<b>5620251</b>	2-Pin Right Angle Male Plug with Stripped Power Wire and #10 Ring on Ground	25	0.03	562 (N)

**Bulk.** Part number indicates single item only. 5624050 must be ordered in multiples of 10. 5620251 must be ordered in multiples of 25.

## 4" Round Backup Light Kit with 10 LEDs



Number of LEDs	10
Size	4"
Connection	STD PL-2

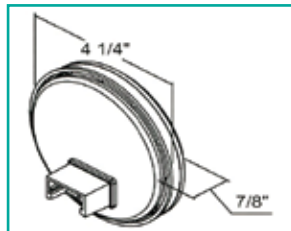

Part No.	Color	Mounting	Amp	Std. Qty	Wt. (lbs.)	Cat.
<b>5624310</b>	Clear	Grommet (Included)	.213	1	0.70	562 (N)
<b>5624350</b>	Clear	Grommet	.213	10	0.36	562 (N)

**Bulk.** Part number indicates single item only. Must order in multiples of 10.

### Accessories

Part No.	Description	Std. Qty	Wt. (lbs.)	Cat.
<b>5624050</b>	Replacement Black Grommet	10	0.15	562 (N)
<b>5620251</b>	2-Pin Right Angle Male Plug with Stripped Power Wire and #10 Ring on Ground	25	0.03	562 (N)

**Bulk.** Part number indicates single item only. 5624050 must be ordered in multiples of 10. 5620251 must be ordered in multiples of 25.



# 4" Round and 6" Oval Backup Lights

## 4" Round Backup Light Kit with 24 LEDs



Number of LEDs	24
Size	4"
Connection	STD PL-2

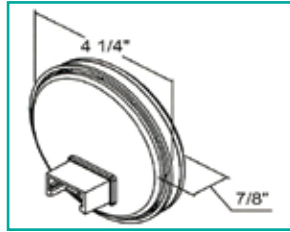

Part No.	Color	Mounting	Amp	Std. Qty	Wt. (lbs.)	Cat.
<b>5624324</b>	Clear	Grommet (Included)	.141	1	0.80	562 (N)
<b>5624325</b>	Clear	Grommet	.141	10	0.42	562 (N)

**Bulk.** Part number indicates single item only. Must order in multiples of 10.

### Accessories

Part No.	Description	Std. Qty	Wt. (lbs.)	Cat.
<b>5624050</b>	Replacement Black Grommet	10	0.15	562 (N)
<b>5620251</b>	2-Pin Right Angle Male Plug with Stripped Power Wire and #10 Ring on Ground	25	0.03	562 (N)

**Bulk.** Part number indicates single item only. 5624050 must be ordered in multiples of 10. 5620251 must be ordered in multiples of 25.

## 6" Oval Backup Light with 6 LEDs



Number of LEDs	6
Size	6"
Connection	STD PL-2

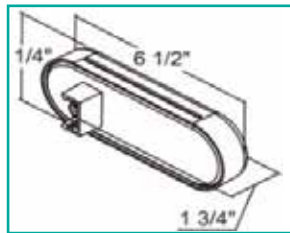

Part No.	Color	Mounting	Amp	Std. Qty	Wt. (lbs.)	Cat.
<b>5626357</b>	Clear	Grommet (Included)	.150	1	0.23	562 (N)
<b>5626356</b>	Clear	Grommet	.150	10	0.23	562 (N)

**Bulk.** Part number indicates single light only. 5626130 must be ordered in multiples of 10.

### Accessories

Part No.	Description	Std. Qty	Wt. (lbs.)	Cat.
<b>5626050</b>	Replacement Black Grommet	10	0.18	562 (N)
<b>5620251</b>	2-Pin Right Angle Male Plug with Stripped Power Wire and #10 Ring on Ground	25	0.03	562 (N)

**Bulk.** Part number indicates single item only. 5626050 must be ordered in multiples of 10. 5620251 must be ordered in multiples of 25.



## 6" Oval Backup Light with 10 LEDs



Number of LEDs	10
Size	6"
Connection	STD PL-2

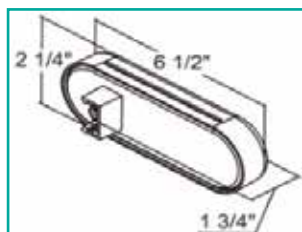

Part No.	Color	Mounting	Amp	Std. Qty	Wt. (lbs.)	Cat.
5626310	Clear	Grommet (Included)	.218	1	0.70	562 (N)
5626311	Clear	Grommet	.138	10	0.38	562 (N)

**Bulk.** Part number indicates single light only. 5626311 must be ordered in multiples of 10.

### Accessories

Part No.	Description	Std. Qty	Wt. (lbs.)	Cat.
5626050	Replacement Black Grommet	10	0.18	562 (N)
5620251	2-Pin Right Angle Male Plug with Stripped Power Wire and #10 Ring on Ground	25	0.03	562 (N)

**Bulk.** Part number indicates single item only. 5626050 must be ordered in multiples of 10. 5620251 must be ordered in multiples of 25.

## 6" Oval Backup Light with 24 LEDs



Number of LEDs	24
Size	6"
Connection	STD PL-2

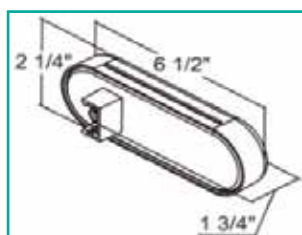

Part No.	Color	Mounting	Amp	Std. Qty	Wt. (lbs.)	Cat.
5626324	Clear	Grommet (Included)	.138	1	0.86	562 (N)
5626325	Clear	Grommet	.218	10	0.43	562 (N)

**Bulk.** Part number indicates single light only. 5626325 must be ordered in multiples of 10.

### Accessories

Part No.	Description	Std. Qty	Wt. (lbs.)	Cat.
5626050	Replacement Black Grommet	10	0.18	562 (N)
5620251	2-Pin Right Angle Male Plug with Stripped Power Wire and #10 Ring on Ground	25	0.03	562 (N)

**Bulk.** Part number indicates single item only. 5626050 must be ordered in multiples of 10. 5620251 must be ordered in multiples of 25.

# 5" Rectangular Backup Lights

## 5.3" Rectangular Backup Light Kit with 32 LEDs



Number of LEDs	32
Size	5.33"
Connection	STD PL-2

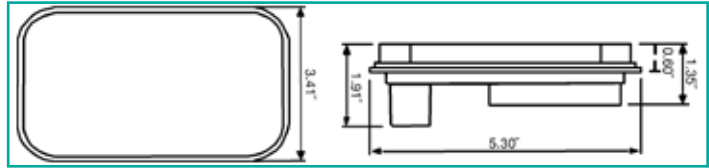

Part No.	Color	Mounting	Amp	Std. Qty	Wt. (lbs.)	Cat.
5625332	Clear	Grommet (Included)	.301	1	0.55	562 (N)

### Accessories

Part No.	Description	Std. Qty	Wt. (lbs.)	Cat.
5620251	2-Pin Right Angle Male Plug with Stripped Power Wire and #10 Ring on Ground	25	0.03	562 (N)

**Bulk.** Part number indicates single light only. 5620350 must be ordered in multiples of 25.



## 1.5" Round License/Utility Light with 4 LEDs



Number of LEDs	4
Size	1.5"
Connection	Hard Wired with Stripped Leads

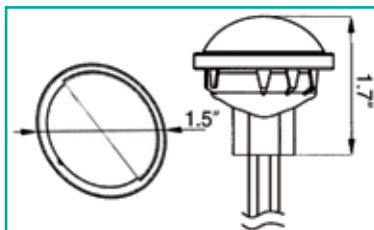

Part No.	Color	Mounting	Amp	Std. Qty	Wt. (lbs.)	Cat.
5621534	Clear	Snap In	.030	1	0.10	562 (N)

Two lights needed to meet DOT requirements.

## 2" License/Utility Light with 2 LEDs Series



Number of LEDs	4
Size	2"

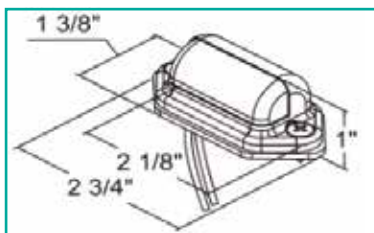

Part No.	Housing Color	Connection	Mounting	Amp	Std. Qty	Wt. (lbs.)	Cat.
5622032	Chrome	Hard Wired with Stripped Leads	Surface	.047	1	0.07	562 (N)
5622132	Chrome	Hard Wired with Stripped Leads	Surface	.047	10	0.07	562 (N)
5622130	Black	Hard Wired with Stripped Leads	Surface	.047	10	0.07	562 (N)
5622133	Chrome	Hard Wired with .180 Male Bullets	Surface	.047	10	0.08	562 (N)

**Bulk.** Part number indicates single light only. 5622132, 5622130 and 5622133 must be ordered in multiples of 10.  
Two lights needed to meet DOT requirements.



# License / Utility Plate Lights and Plugs

## 2" Surface Mount License Plate Light Kit



Number of LEDs	2
Size	2"
Connection	Hard Wired with .180 Male Bullets

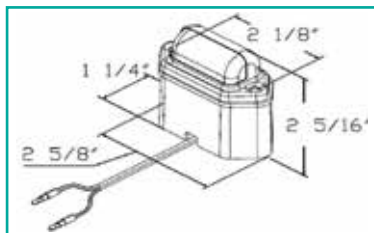

Part No.	Color	Mounting	Amp	Std. Qty	Wt. (lbs.)	Cat.
5622134	Clear	Surface	.047	10	0.13	562 (N)

**Bulk.** Part number indicates single item only. Must order in multiples of 10.

## 2.75" License Plate Light with 2 LEDs



Number of LEDs	2
Size	2.75"
Connection	Hard Wired with Stripped Leads

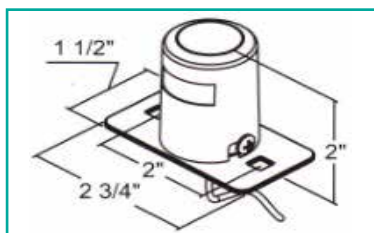

Part No.	Color	Mounting	Amp	Std. Qty	Wt. (lbs.)	Cat.
5622754	Clear	Surface	.086	10	0.17	562 (N)

**Bulk.** Part number indicates single item only. Must order in multiples of 10. Two lights needed to meet DOT requirements.

## DOT Turn Signal Equalizer Plugs

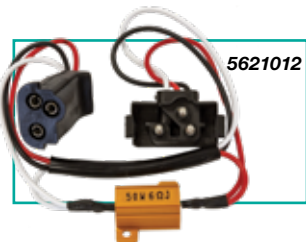
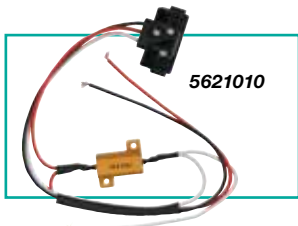

Part No.	Description	Wt. (lbs.)	Cat.
5621010	50 Watt LED Turn Signal Equalizer with Right Angle Male PL-3 Plug and Stripped Leads	0.12	562 (N)
5621012	50 Watt LED Turn Signal Equalizer with Right Angle Male PL-3 Plug and Straight Female PL-3 Plug	0.15	562 (N)



## DOT Light Plugs

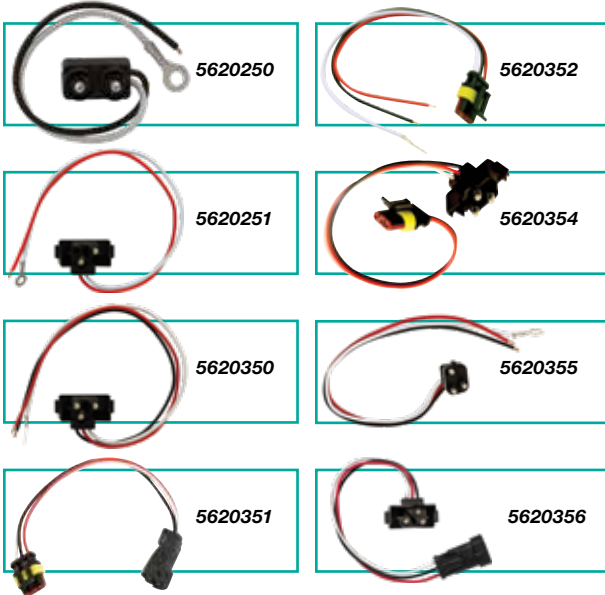

Part No.	Description	Wt. (lbs.)	Cat.
5620250	2-Pin In-Line Male PL-10 Plug with Stripped Power Wire and #10 Ring on Ground	0.03	562 (N)
5620251	2-Pin Right Angle Male Plug with Stripped Power Wire and #10 Ring on Ground	0.03	562 (N)
5620350	3-Pin Right Angle Male PL-3 Plug with Stripped Leads and #10 Ring on Ground	0.03	562 (N)
5620351	3-Wire AMP-Style Plug, 3-Pin Straight Female PL-3 Plug	0.07	562 (N)
5620352	3-Wire AMP-Style Plug, with Stripped Leads and #10 Ring on Ground	0.03	562 (N)
5620354	3-Wire AMP-Style Plug, with 3-Pin Right Angle Male PL-3 Plug	0.06	562 (N)
5620355	3-Wire, 3-Pin Straight Male PL-3 Plug with Stripped Leads and #10 Ring on Ground	0.05	562 (N)
5620356	3-Wire AMP-Style Plug, with 3-Pin Right Angle Male PL-3 Plug	0.06	562 (N)

## DOT Reflectors



Part No.	Description	Std. Qty	Wt. (lbs.)	Cat.
5623316	3-3/16" Round, Bolt-on, Red	10	0.50	889 (N)
5623317	3-3/16" Round, Bolt-on, Amber	10	0.50	889 (N)
5623000	3" Round, Stick-on, Red, 100 per Roll	1 Roll	0.55	889 (N)
5623001	3" Round, Stick-on, Amber, 100 per Roll	1 Roll	0.55	889 (N)
5623520	3-1/2" Rectangular, Stick-on, Red, 500 per Roll	1 Roll	2.20	889 (N)
5623521	3-1/2" Rectangular, Stick-on, Amber, 500 per Roll	1 Roll	2.20	889 (N)

## DOT Conspicuity Tape

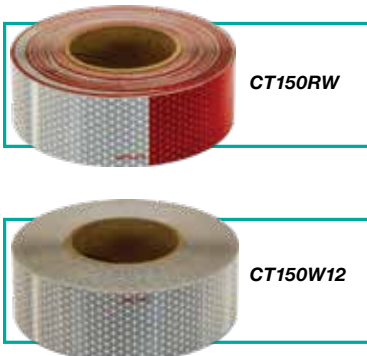

- DOT approved
- ASTM D4956 - 93B Type V
- LS300C
- FP92
- NHTSA 49 CFT, Part 571, DOT-C2
- 5-Year Rating

Part No.	Description	Std. Qty	Wt. (lbs.)	Cat.
CT150RW	DOT Conspicuity Tape, 150' Roll, 11" Red, 7" White	1	1.5	889 (N)
CT150W12	150' Roll, White, 12" Lengths	1	1.5	889 (N)

Stays on for up to five years with proper installation.

# Light Bar Kits

## 44" Light Bar Kits



8891144



8891145

Part No.	Description	Cat.
8891144 (Round)	(1) 304 Stainless Steel Light Box, Dimension: 44" L x 8" H x 3" D (2) 4" Round STT Lights, 10 Red LEDs (2) 4" Round Strobe Lights, 24 Amber LEDs (3) 2.5" Round Marker Lights, 4 Red LEDs (1) Wire Harness (2) LED Load Equalizers	889 (N)

Fixed & hinged mounting options included.

Part No.	Description	Cat.
8891145 (Oval)	(1) 304 Stainless Steel Light Box, Dimension: 44" L x 8" H x 3" D (2) 6" Oval STT Lights, 10 Red LEDs (2) 6" Oval Strobe Lights, 24 Amber LEDs (3) 2.5" Round Marker Lights, 4 Red LEDs (1) Wire Harness (2) LED Load Equalizers	889 (N)

Fixed & hinged mounting options included.

## 66" Light Bar Kits



8891150



8891166



8891167



8891168



8891169

Part No.	Description	Cat.
8891150 (Oval)	(1) 304 Stainless Steel Light Box, Dimension: 66" L x 4" H x 3" D (2) 6.5" Oval STT Lights, 10 Red LEDs (2) 6.5" Oval Strobe Lights, 24 Amber LEDs (3) .75" Round Marker Lights, 3 Red LEDs (1) Wire Harness (2) LED Load Equalizers/Turn Signals	889 (N)

Fixed & hinged mounting options included.

Part No.	Description	Cat.
8891166 (Round)	(1) 304 Stainless Steel Light Box, Dimension: 66" L x 8" H x 3" D (2) 4" Round STT Lights, 10 Red LEDs (2) 4" Round Back-Up Lights, 10 Clear LEDs (2) 4" Round Strobe Lights, 24 Amber LEDs (3) 2.5" Round Marker Lights, 4 Red LEDs (1) Wire Harness (2) LED Load Equalizers	889 (N)

Fixed & hinged mounting options included.

Part No.	Description	Cat.
8891167 (Round)	(1) 304 Stainless Steel Light Box, Dimension: 66" L x 8" H x 3" D (4) 4" Round STT Lights, 10 Red LEDs (2) 4" Round Strobe Lights, 24 Amber LEDs (3) 2.5" Round Marker Lights, 4 Red LEDs (1) Wire Harness (2) LED Load Equalizers	889 (N)

Fixed & hinged mounting options included.

Part No.	Description	Cat.
8891168 (Oval)	(1) 304 Stainless Steel Light Box, Dimension: 66" L x 8" H x 3" D (2) 6" Oval STT Lights, 10 Red LEDs (2) 6" Oval Back-Up Lights, 10 Clear LEDs (3) 2.5" Round Marker Lights, 4 Red LEDs (1) Wire Harness (2) LED Load Equalizers	889 (N)

Fixed & hinged mounting options included.

Part No.	Description	Cat.
8891169 (Oval)	(1) 304 Stainless Steel Light Box, Dimension: 66" L x 8" H x 3" D (4) 6" Oval STT Lights, 10 Red LEDs (2) 6" Oval Strobe Lights, 24 Amber LEDs (3) 2.5" Round Marker Lights, 4 Red LEDs (1) Wire Harness (2) LED Load Equalizers	889 (N)

Fixed & hinged mounting options included.





## 77" Light Bar Kits



Part No.	Description	Cat.
8891177 (Oval)	(1) 304 Stainless Steel Light Box, Dimension: 77" L x 4" H x 3" D (2) 6.5" Oval Strobe Lights, 24 Amber LEDs (2) 6.5" Oval Back-Up Lights, 10 Clear LEDs (2) 6.5" Oval STT, 10 Red LEDs (3) .75" Round Marker Lights, 3 Red LEDs (1) Wire Harness (2) LED Load Equalizers	889 (N)

Fixed & hinged mounting options included.

Part No.	Description	Cat.
8891178 (Oval)	(1) 304 Stainless Steel Light Box, Dimension: 77" L x 4" H x 3" D (4) 6" Oval STT Lights, 10 Red LEDs (2) 6" Oval Strobe Lights, 24 Amber LEDs (3) .75" Round Marker Lights, 3 Red LEDs (1) Wire Harness (2) LED Load Equalizers/Turn Signal	889 (N)

Fixed & hinged mounting options included.



8891168 shown



# DOT Light Boxes

## 44" Stainless Steel Light Bar for Round Lights



Part No.	Description	Cat.
LB8443SST	(4) 4" and (3) 2-1/2" Round Cutouts, 8" x 3" x 44" (Lights Not Included)	903-1 (N)

Fixed & hinged mounting options included.

## 44" Stainless Steel Light Bar for Oval Lights



Part No.	Description	Cat.
LB8445SST	(4) 6" Oval and (3) 2-1/2" Round Cutouts, 8" x 3" x 44" (Lights Not Included)	903-1 (N)

Fixed & hinged mounting options included.

## 66" Stainless Steel Light Bar for Round Lights



Part No.	Description	Cat.
LB8663SST	(6) 4" and (3) 2-1/2" Round Cutouts, 8" x 3" x 66" (Lights Not Included)	903-1 (N)

Fixed & hinged mounting options included.

## 66" Stainless Steel Light Bar for Oval Lights



Part No.	Description	Cat.
LB8665SST	(6) 6" Oval and (3) 2-1/2" Round Cutouts, 8" x 3" x 66" (Lights Not Included)	903-1 (N)

Fixed & hinged mounting options included.

## 66" Stainless Steel Light Bar for Large Oval Lights



Part No.	Description	Cat.
LB4663SST	(4) 6" Oval and (3) 3/4" ID Marker Light Cutouts, 4" x 3" x 66" (Lights Not Included)	903-1 (N)

Mounting hardware included.

## 77" Stainless Steel Light Bar for Oval Lights



Part No.	Description	Cat.
LB4773SST	(6) 6" Oval and (3) 3/4" ID Marker Light Cutouts, 4" x 3" x 77" (Lights Not Included)	903-1 (N)

Mounting hardware included.



## Wiring Harness

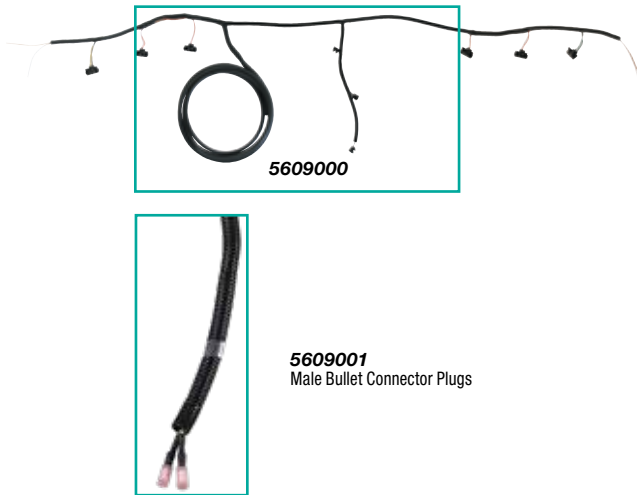

Part No.	Description	Cat.
5609000	12' Wiring Harness	560 (N)
5609001	12' Wiring Harness with 3 Female Bullet Connectors for use with 3/4" ID Marker Lights with Male Bullet Connectors on LB4663SST and LB4773SST	560 (N)

Wiring harness, 12' lead, universal rear DOT.  
7 and 9 light bar wiring.

## Single Oval Light Boxes



Part No.	Description	Cat.
LB383	Single Oval, Black Powder-Coated Steel, (3" x 8" x 3")	520 (N)



Part No.	Description	Cat.
LB383SL	Single Oval with Side Light, Black Powder-Coated Steel, (3" x 8" x 3")	520 (N)



Part No.	Description	Cat.
LB383SST	Single Oval, Stainless Steel, (3" x 8" x 3")	520 (N)



Part No.	Description	Cat.
LB383ALDT	Single Oval, Diamond Tread Aluminum, (3" x 8" x 3")	520 (N)



Part No.	Description	Cat.
LB383ALSM	Single Oval, Smooth Aluminum, (3" x 8" x 3")	520 (N)



Part No.	Description	Cat.
LB383P	Single Oval, Black Polymer, (3" x 8" x 3")	520 (N)



Part No.	Description	Cat.
LB384	Single Oval, Both Front and Back, Black Powder-Coated Steel, (3" x 8" x 4")	520 (N)



Part No.	Description	Cat.
LB384SST	Single Oval, Both Front and Back, Stainless Steel, (3" x 8" x 3")	520 (N)

# DOT Light Boxes

## Dual Oval Light Boxes



Part No.	Description	Cat.
LB3163	Dual Oval Black Powder-Coated Steel, (3" x 16" x 3")	520 (N)



Part No.	Description	Cat.
LB3163SST	Dual Oval Stainless Steel, (3" x 16" x 3")	520 (N)

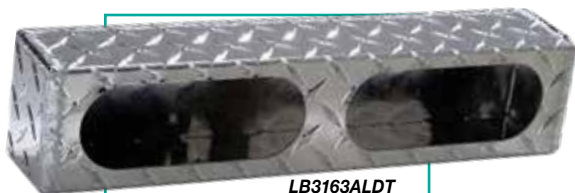

Part No.	Description	Cat.
LB3163ALDT	Dual Oval Diamond Tread Aluminum, (3" x 16" x 3")	520 (N)

## Triple Oval Light Boxes



Part No.	Description	Cat.
LB3253	Triple Oval, Black Powder-Coated Steel, (3" x 25" x 3")	520 (N)



Part No.	Description	Cat.
LB3253ALDT	Triple Oval Diamond Tread Aluminum, (3" x 25" x 3")	520 (N)



Part No.	Description	Cat.
LB3253SST	Triple Oval Stainless Steel, (3" x 25" x 3")	520 (N)



Part No.	Description	Cat.
LB8133	Triple Oval Vertical or Horizontal, Steel, Gray Primer, (8" x 13" x 3")	520 (N)



## Single Round Light Boxes



LB663

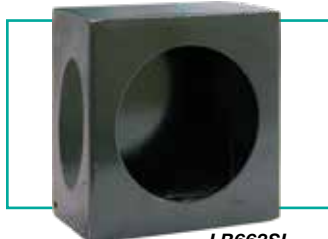

LB663SL



LB663SST

Part No.	Description	Cat.
LB663	Single Round Black Powder-Coated Steel, (6" x 6" x 3")	520 (N)

Part No.	Description	Cat.
LB663SL	Single Round with 2" Side Light, Black Powder-Coated Steel, (6" x 6" x 3")	520 (N)

Part No.	Description	Cat.
LB663SST	Single Round Stainless Steel, (6" x 6" x 3")	520 (N)

## Dual Round Light Boxes



LB6123



LB6123SST



LB6123ALDT

Part No.	Description	Cat.
LB6123	Dual Round, Black Powder-Coated Steel, (6" x 12" x 3")	520 (N)

Part No.	Description	Cat.
LB6123SST	Dual Round, Stainless Steel, (6" x 12" x 3")	520 (N)

Part No.	Description	Cat.
LB6123ALDT	Dual Round, Diamond Tread Aluminum, (6" x 12" x 3")	520 (N)



# DOT Light Boxes

## Triple Round Light Boxes



Part No.	Description	Cat.
LB6183	Triple Round, Black Powder-Coated Steel, (6" x 18" x 3")	520 (N)



Part No.	Description	Cat.
LB6183SST	Triple Round, Stainless Steel, (6" x 18" x 3")	520 (N)



Part No.	Description	Cat.
LB6183ALDT	Triple Round, Diamond Tread Aluminum, (6" x 18" x 3")	520 (N)

## DOT Light Mounting Brackets



Part No.	Description	Cat.
LB1	Single Oval, Black, 8.25" x 4.0"	520 (N)



Part No.	Description	Cat.
LB1SS	Single Oval, Stainless Steel, 8.25" x 4.0"	520 (N)



## Triple Round Light Boxes with Mudflap Mount



Part No.	Description	Cat.
LB6303SST	Triple Round, Stainless Steel Kit, (6" x 30" x 3") Both Driver and Passenger Side	520 (N)
LB6304SST	Triple Round, Stainless Steel, (6" x 30" x 3") Driver Side	520 (N)
LB6305SST	Triple Round, Stainless Steel, (6" x 30" x 3") Passenger Side	520 (N)

Combination lightbox-mudflap mounts.

Accommodates (3) 4" round recessed or surface mount lights per box.

Spring loaded for impact protection.



# Observation Systems

## Rear Observation System with Night Vision Camera

2-YEAR  
**W**  
12-24  
VOLTS  
**IP**  
67

Screen	7" TFT-LCD Color Monitor
Cable Length	65'
Mount	Standard U Bracket, Pedestal, and Flush Mount



- Auto reverse "on"
- Audio
- Removable sun visor
- Heated night vision camera
- Supports multiple camera feeds (*additional cameras sold separately*)
- Wireless remote

Part No.	Description	Wt. (lbs.)	Cat.
 8883000	Rear Observation System, Standard Camera	5.5	888 (N)

## Rear Observation System with License Plate Night Vision Camera

2-YEAR  
**W**  
12-24  
VOLTS  
**IP**  
67

Screen	7" TFT-LCD Color Monitor
Cable Length	65'
Mount	Standard U Bracket, Pedestal, and Flush Mount



- Auto reverse "on"
- Audio
- Removable sun visor
- License plate night vision camera
- Supports multiple camera feeds (*additional cameras sold separately*)
- Wireless remote

Part No.	Description	Wt. (lbs.)	Cat.
 8883010	Rear Observation System, License Plate Camera	5.5	888 (N)

## Rear Observation System with Recessed Night Vision Camera

2-YEAR  
**W**  
12-24  
VOLTS  
**IP**  
67

Screen	7" TFT-LCD Color Monitor
Cable Length	65'
Mount	Standard U Bracket, Pedestal, and Flush Mount



- Auto reverse "on"
- Audio
- Removable sun visor
- Recessed night vision camera
- Supports multiple camera feeds (*additional cameras sold separately*)
- Wireless remote

Part No.	Description	Wt. (lbs.)	Cat.
 8883020	Rear Observation System, 1" Diameter Recessed Bullet Camera	5.5	888 (N)



## Rearview Mirror Monitor Rear Observation System with Night Vision Camera

**2-YEAR**  
**W**  
**12-24**  
**VOLTS**  
**IP**  
**67**

Screen	4.3" TFT-LCD Mirror Monitor <i>(Replaces OEM Mirror)</i>
Cable Length	50'



- Auto reverse "on"
- Illuminated touch screen buttons
- Compact, IP68 back-up camera with night vision

Part No.	Description	Wt. (lbs.)	Cat.
8883030	Rear Observation System, Universal OEM 4.3" Monitor	1.88	888 (N)

## Quad Screen Rear Observation System with Night Vision Backup Camera

**2-YEAR**  
**W**  
**12-24**  
**VOLTS**  
**IP**  
**67**

Screen	7" TFT-LCD Color Quad Screen Monitor
Cable Length	65'
Mount	Standard U Bracket, Pedestal, and Flush Mount



- Auto reverse "on"
- Audio
- Removable sun visor
- Heated night vision camera with audio
- Shows up to 4 adjustable camera views on same screen *(additional cameras sold separately)*
- Wireless remote

Part No.	Description	Wt. (lbs.)	Cat.
8883040	Rear Observation System, Quad Screen (1) Standard Camera	5.5	888 (N)

## Wireless Rear Observation System with Backup Camera

**2-YEAR**  
**W**  
**12-24**  
**VOLTS**  
**IP**  
**67**

Screen	7" TFT-LCD Color Wireless Monitor
Cable Length	65'
Mount	Standard U Bracket and Suction Cup



- Auto reverse "on"
- Audio
- Removable sun visor
- Wireless night vision camera with audio
- Wireless remote
- New dual antenna provides stronger signal strength

Part No.	Description	Wt. (lbs.)	Cat.
8883210*	Wireless Rear Observation System	3.2	888 (N)



# Observation Systems

## Color Camera with Heated Night Vision and Audio

**2-YEAR  
W**  
**12-24  
VOLTS**  
**IP  
67**



Part No.	Description	Wt. (lbs.)	Cat.
8883101	Camera, Standard, IP67, Night Vision, Heated, Audio	0.01	888 (N)

## License Plate Mount Camera with Night Vision

**1-YEAR  
W**  
**12-24  
VOLTS**  
**IP  
67**



Part No.	Description	Wt. (lbs.)	Cat.
8883102	License Plate, Waterproof, 4-Pin	0.01	888 (N)

## Color Bullet Camera for Recessed Mounting with Night Vision

**1-YEAR  
W**  
**12-24  
VOLTS**  
**IP  
67**



Part No.	Description	Wt. (lbs.)	Cat.
8883103	Camera, Recessed 1" Dia. Bullet, IP67, Night Vision	0.01	888 (N)

## Surface Side Mount Camera, Color with Night Vision

**1-YEAR  
W**  
**12-24  
VOLTS**  
**IP  
67**



Part No.	Description	Wt. (lbs.)	Cat.
8883104	Camera, Side, Universal, IP67, Night Vision	0.01	888 (N)

## Sphere Surface Mount Camera with Night Vision

**1-YEAR  
W**  
**12-24  
VOLTS**  
**IP  
67**



Part No.	Description	Wt. (lbs.)	Cat.
8883105	Sphere Surface Mount, Waterproof, 4-Pin	0.01	888 (N)

## Surface Mount Cube Camera, Color with Night Vision

**1-YEAR  
W**  
**12-24  
VOLTS**  
**IP  
67**



Part No.	Description	Wt. (lbs.)	Cat.
8883106	Cube Surface Mount, Camera, Waterproof, 4-Pin	0.01	888 (N)

## Dual Camera with Night Vision

**1-YEAR  
W**  
**12-24  
VOLTS**  
**IP  
67**



Part No.	Description	Wt. (lbs.)	Cat.
8883108	Dual Camera, Waterproof, 4-Pin	0.01	888 (N)



## Wireless Waterproof Color Camera with Night Vision and Audio

1-YEAR  
**W**  
12-24  
VOLTS  
**IP**  
67



Part No.	Description	Wt. (lbs.)	Cat.
8883215*	Camera, Standard, IP67, Night Vision, Heated, Wireless, for use with 8883210	0.01	888 (N)

## Universal Camera Washing System



- High pressure
- Works with camera: **8883101**
- Includes: 1-1/2 quart tank with mounting bracket, 9-1/2 ft fluid tube with pressure nozzle, Pump, in-cab controller, 32 ft power cord, mounting hardware.

Part No.	Description	Wt. (lbs.)	Cat.
8882150	Universal Camera Washing System, 12-24 VDC	0.01	888 (N)

## Camera Cable for Rear Observation Systems and Backup Cameras

1-YEAR  
**W**  
12-24  
VOLTS  
**IP**  
67



Part No.	Description	Wt. (lbs.)	Cat.
8883116	Cable, 16'/5m	0.01	888 (N)
8883132	Cable, 32'/10m	0.01	888 (N)
8883165	Cable, 65'/20m	0.01	888 (N)
8883182	Cable, 82'/25m	0.01	888 (N)

## Work Lights with Built-In Backup Cameras

5-YEAR  
**W**  
12-24  
VOLTS  
**IP**  
67

Number of LEDs	8
Lumens	1,100
Lead Length	18"
Mount / Base	8mm Stud, SST

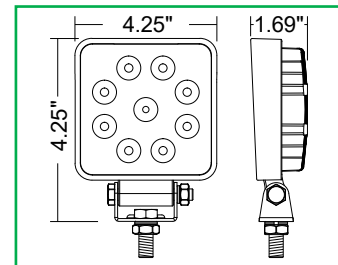
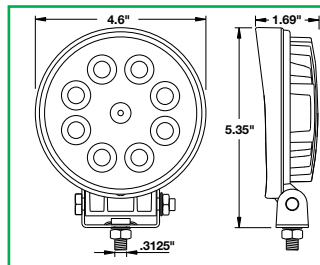

### Round Work Lamp Camera

Part No.	Type	Color	Amp	Connection	Wt. (lbs.)	Cat.
8883110	Flood	Clear	2.33	Deutsch	1.45	562 (N)

Durable camera features a 976 (H) x 592 (V) pixel resolution. Night vision capabilities and a wide 140° viewing angle to help capture everything going on even in low visibility situations.

### Square Work Lamp Camera

Part No.	Type	Color	Amp	Connection	Wt. (lbs.)	Cat.
8883111	Flood	Clear	2.33	Deutsch	1.45	562 (N)

Durable camera features a 976 (H) x 592 (V) pixel resolution. Night vision capabilities and a wide 140° viewing angle to help capture everything going on even in low visibility situations.

# Booster Cables

## Booster Cables with Quick Connect



### 600 Amp Gray Plug-In Quick Connect Kit

Part No.	Length	Wire Gauge	Amp	Wt. (lbs.)	Cat.
 5601025	28'	4	600	13	560 (N)

### Replacement Parts

Part No.	Description	Wt. (lbs.)	Cat.
5601020	6' Battery Side Cable with Gray Plug-In Quick Connect for <b>5601025</b>	2.7	560 (N)
5601015	Gray Plug-In Quick Connect Replacement Kit for <b>5601025</b>	0.78	560 (N)



### 600 Amp Blue Plug-In Quick Connect Kit

Part No.	Length	Wire Gauge	Amp	Wt. (lbs.)	Cat.
 5601026	28'	4	600	13	560 (N)

### Replacement Parts

Part No.	Description	Wt. (lbs.)	Cat.
5601021	6' Battery Side Cable with Blue Plug-In Quick Connect for <b>5601026</b>	2.7	560 (N)
5601016	Blue Plug-In Quick Connect Replacement Kit for <b>5601026</b>	0.78	560 (N)



### 800 Amp Red Plug-In Quick Connect Kit

Part No.	Length	Wire Gauge	Amp	Wt. (lbs.)	Cat.
 5601032	32.5'	1	800	23.1	560 (N)

### Replacement Parts

Part No.	Description	Wt. (lbs.)	Cat.
5601022	7.5' Battery Side Cable with Red Plug-In Quick Connect for <b>5601032</b>	2.7	560 (N)
5601017	Red Plug-In Quick Connect Replacement Kit for <b>5601032</b>	0.78	560 (N)



### 1000 Amp Black Plug-In Quick Connect Kit

Part No.	Length	Wire Gauge	Amp	Wt. (lbs.)	Cat.
 5601033	32.5'	1	1000	28.6	560 (N)

### Replacement Parts

Part No.	Description	Wt. (lbs.)	Cat.
5601023	7.5' Battery Side Cable with Black Plug-In Quick Connect for <b>5601033</b>	2.7	560 (N)
5601018	Black Plug-In Quick Connect Replacement Kit for <b>5601033</b>	0.78	560 (N)



## 4" LED Rechargeable Magnetic Road Flares

**IP  
67**

LEDs Per Flare	16
Number of Flash Patterns	10
Color	Amber
Run Time	8 - 60 Hours
Recharge Time	4 - 5 Hours
Housing	Crush-Proof with Magnetic Bottom
Charger	120V Wall Charger 12V Vehicle Charger

- Includes steady-on "flashlight mode"
- Strobes float in water
- Flares charge in the storage case



**8891016**  
Single road strobe/flare



**8891017**  
Case of 4 road strobe/flares



**8891018**  
Case of 6 road strobe/flares

### Single Road Strobe Flare

Part No.	Number of Flares	Amp	Wt. (lbs.)	Cat.
 <b>8891016</b>	1	0.5	0.85	889 (N)

### 4 Road Strobe Flare Case

Part No.	Number of Flares	Amp	Wt. (lbs.)	Cat.
 <b>8891017*</b>	4	0.5	5.00	889 (N)

### 6 Road Strobe Flare Case

Part No.	Number of Flares	Amp	Wt. (lbs.)	Cat.
 <b>8891018</b>	6	0.5	6.42	889 (N)





# Towing Lights and Backup Alarms

## Heavy-Duty Towing Light Set

Bulb Type	Incandescent
Housing	Rubber
Mounting	Magnetic

Visible for up to one mile.



Part No.	Lens Color	Lead Length	Connection	Wt. (lbs.)	Cat.
TL257M	Red	30'	4 Pin Round Connector	5.32	560 (N)

## Self-Grounding Backup Alarms

**2-YEAR**  
**W**  
**12-24**  
**VOLTS**  
**IP**  
**65**

Housing	Nylon
---------	-------

Meets OSHA, Bureau of Mines, GSA & all state regulations.



97 Decibel <span style="float: right;">SAE J994</span>				
Part No.	Decibels	Size	Wt. (lbs.)	Cat.
BA0972	97 dB	4" x 1-5/8" x 2-5/8"	0.42	888 (N)



102 Decibel <span style="float: right;">SAE J994</span>				
Part No.	Decibels	Size	Wt. (lbs.)	Cat.
BA102	102 dB	4" x 1-5/8" x 2-5/8"	0.60	888 (N)



107 Decibel <span style="float: right;">SAE J994</span>				
Part No.	Decibels	Size	Wt. (lbs.)	Cat.
BA107	107 dB	4" x 1-3/4" x 3-1/16"	0.68	888 (N)

## Pre-Wired Single Switch Panel



- Single switch panel, prewired and fused
- 10 Amp, "On/Off"
- Backlit

Part No.	Description	Wt. (lbs.)	Cat.
 <b>6391001</b>	Single Switch Panel, On-Off Illuminated, 2"L x 1.625"W x 2.25"T	0.22	639 (N)

## Pre-Wired Double Switch Panel



- Double switch panel, prewired and fused
- 15 Amp, "On/Off"
- Backlit

Part No.	Description	Wt. (lbs.)	Cat.
 <b>6391002</b>	Double Switch Panel, On-Off Illuminated, 3"L x 1.625"W x 2.25"T	0.29	639 (N)

## Pre-Wired Triple Switch Panel



- Triple switch panel, prewired and fused
- 20 Amp, "On/Off"
- Backlit

Part No.	Description	Wt. (lbs.)	Cat.
 <b>6391003</b>	Triple Switch Panel, On-Off Illuminated, 3.875"L x 1.625"W x 2.25"T	0.29	639 (N)

## Pre-Wired Quad Switch Panel



- Quad switch panel, prewired and fused
- 20 Amp, "On/Off"
- Backlit

Part No.	Description	Wt. (lbs.)	Cat.
 <b>6391004</b>	Quad Switch Panel, On-Off Illuminated, 4.75"L x 1.625"W x 2.25"T	0.29	639 (N)

## Single On/Off Switch



Part No.	Description	Wt. (lbs.)	Cat.
<b>6391101</b>	Replacement Rocker Switch, On/Off Red, 12VDC	0.02	639 (N)

# Switch Panels

## 4 Switch Panel, Pre-Wired



- Built-in traffic advisor controls
- For use with 49", 54" & 60" modular light bars

Part No.	Description	Wt. (lbs.)	Cat.
6391204	4-Switch Panel, Pre-Wired, 3.75"L x 1.25"W x 1.5"T	0.27	639 (N)

## 5 Switch Panel, Pre-Wired



- For use with 49", 54" & 60" modular light bars, plus surface and recessed mounted strobes

Part No.	Description	Wt. (lbs.)	Cat.
6391205	5-Switch Panel, Pre-Wired, 3.5"L x 1.0"W x 2.5"T	0.35	639 (N)

## 6 Switch Panel, Pre-Wired with LED Pattern Display for use with Modular Light Bars



- Built-in traffic advisor controls
- For use with 49", 54" & 60" modular light bars

Part No.	Description	Wt. (lbs.)	Cat.
6391206	6-Switch Panel, Pre-Wired with LED Pattern Display, 6.5"L x 0.75"W x 2.75"T	0.39	639 (N)

## 6 Switch Panel, Pre-Wired with LED Pattern Display for use with Directional Warning Lights



- Built-in traffic advisor controls
- For use with Directional Warning Lights 8894037 and 8894047

Part No.	Description	Wt. (lbs.)	Cat.
6391207	6-Switch Panel, Pre-Wired with LED Pattern Display, 6.5"L x 0.75"W x 2.75"T	0.39	639 (N)

## 7 Function Programmable Switch Panel



- The programmable panel supports up to 7 functions, and can be used to control multiple lights and/or other equipment
- For use with 49", 54" & 60" modular light bars

Part No.	Description	Wt. (lbs.)	Cat.
6391208	Switch Panel, 7 Function, Multi-Purpose, Programmable	0.83	639 (N)

## 8 Function Programmable Switch Panel with Relays



- The programmable panel supports up to 8 functions, and can be used to control multiple lights and/or other equipment
- The relay allows the switch panel to deliver additional amperage to lighting accessories with higher power demands
- For use with 49", 54" & 60" modular light bars

Part No.	Description	Wt. (lbs.)	Cat.
6391209	Switch Panel, 8 Function, Multi-Purpose, Programmable with Relays	0.83	639 (N)



## 8 Function Programmable Switch Panel



- 8 function programmable switch panel comes pre-wired to control up to eight 12V auxiliary devices
- This extremely versatile panel combines 8 relays and 8 circuit breakers into a single compact unit, drastically simplifying the wiring in the vehicle's cab and makes installation clean and simple
- The unit is ideal for a wide range of applications, including crane trucks, brush trucks, and emergency, utility, and municipal vehicles
- The panel features 5 On/Off switches and 3 switches that can be configured as momentary or On/Off to suit your needs
- Each switch is rated for a maximum current of 15 amps with a max of 60 total amps running through the panel at any one time
- The switch panel is backlit and includes a legend with over 120 different switch labels
- Solid state construction removes all moving parts for superior impact and vibration resistance, and durable molex connectors ensure a clean, strong electrical signal

Part No.	Description	Wt. (lbs.)	Cat.
6391308	8 Function Panel Switch, Illuminated-On, Pre-Wired	1.68	639 (N)

## 4 Function Backlit Pre-Wired Switch Box



- 12V pre-wired switch boxes fused with relay & circuit breaker
- Individually fused
- Multiple legends included

Part No.	Description	Wt. (lbs.)	Cat.
6391104	4 Function Backlit Switch Box (3) 20 Amp, (1) 40 Amp	2.4	639 (N)

## 6 Function Backlit Pre-Wired Switch Box



- 12V pre-wired switch boxes fused with relay & circuit breaker
- Individually fused
- Multiple legends included

Part No.	Description	Wt. (lbs.)	Cat.
6391106	6 Function Backlit Switch Box (5) 20 Amp, (1) 40 Amp	2.9	639 (N)

## Single On/Off Switch



Part No.	Description	Wt. (lbs.)	Cat.
6391101	Replacement Rocker Switch, On/Off Red, 12VDC	0.02	639 (N)

## Mini Round Rocker Switches



Part No.	Description	Wt. (lbs.)	Cat.
6391100	On/Off Mini Round Rocker Switch Illuminated, 0.75",Red	0.01	639 (N)



Part No.	Description	Wt. (lbs.)	Cat.
6391102	On/Off Mini Round Rocker Switch, 0.75",Black	0.01	639 (N)



Part No.	Description	Wt. (lbs.)	Cat.
6391103	On/Off/On Mini Round Rocker Switch, 0.75", Black	0.01	639 (N)



Part No.	Description	Wt. (lbs.)	Cat.
6391105	Momentary And On/Off Mini Round Rocker Switch, 0.75", Black	0.01	639 (N)



# Switches

## Rocker Switch & Bracket



- Commonly used with tarp gear motors

Part No.	Description	Wt. (lbs.)	Cat.
<b>3014187</b>	12 Volt, Double Momentary Open/Close	2.9	639 (N)
<b>3014188</b>	Rocker Switch Bracket	2.9	639 (N)

## Pre-wired Switch with Momentary Button



- On-off, flash pattern control
- 15' Pre-wired cable
- 10 Amp
- 2-1/2" L x 1-1/2" W x 1" H

Part No.	Description	Wt. (lbs.)	Cat.
<b>6391215</b>	Switch Panel, On-Off with Flash Pattern	1.0	639 (N)

## LED Strobe Controller



- LED strobe flasher
- Includes 2-sided 3M mounting tape and 3 wire taps
- 12-24V
- 6 Amps
- Commonly used with strip lights on page 28 and 29

Part No.	Description	Wt. (lbs.)	Cat.
 <b>5621002</b>	LED Strobe Controller with 6" Leads, Converts Steady-On Strip Lights to a Strobe Pattern	0.07	639 (N)

## Panel Mount Momentary Push-Button Switch



- Weatherproof, dust proof, single pole, single throw
- Rubber cap & mounting nut assembly, two screw terminals with lock-washers
- Mounting stem 5/8"-32 Thd., 21/32" long
- Max 35 amps

Part No.	Description	Wt. (lbs.)	Cat.
<b>BSW90030</b>	Switch, Momentary Push Button	0.11	639 (N)

## Heavy Duty Rotary On/Off Switch



- Single pole battery disconnect, two position (on & off)
- 12V DC, 20A continuous 125A intermittent +15 sec.on, min off
- Two 3/8" copper terminal studs
- Brass mounting stem
- 3/4"-16 Thd., 23/32" long, fits through 3/16" thick panel

Part No.	Description	Wt. (lbs.)	Cat.
<b>SW700</b>	Switch with Face Plate	0.89	639 (N)



## 50 AMP Rotary Switch



- Commonly used with tarp gear motors
- Heavy-duty 50 AMP rotary switch controls forward and reverse motion of a 12-volt motor (No relay required)
- Momentary on/off/momentary on lever type actuator
- 4 screw terminals with silver laminated contacts
- M12 x 1.0 mounting threads
- Aluminum name plate included

Part No.	Description	Wt. (lbs.)	Cat.
<b>SW710</b>	Switch, 50 AMP, Rotary, Momentary	0.39	639 (N)

## High/Low Beam Push-Button Switch



- Single pole, single throw switch with 5/16"-24 Thd.
- Stud terminals 29/32" mounting holes 1-3/4" on center
- Top of button extends 1" above faceplate

Part No.	Description	Wt. (lbs.)	Cat.
<b>BSW002</b>	Switch, Tailgate, Heavy-Duty	0.36	600 (N)

## 12 Volt Momentary Switch



- Push for ON, Spring return for OFF
- Two brass terminals
- Two 5/8"-32 brass screws
- 2-5/16" long OD
- 5/8" diameter mounting hole, fits through 3/4" thick panel
- Moisture repellent insulator

Part No.	Description	Wt. (lbs.)	Cat.
<b>SW901</b>	Switch, Momentary, 12V, (2) Terminals	0.12	600 (N)

## 12V Recessed Toggle Switch

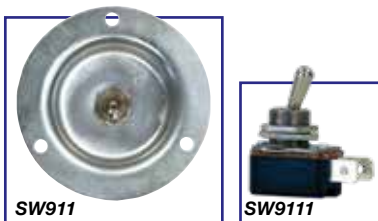

- 12 VDC, 10 AMP switch with panel mount
- Two blade terminals
- Recessed pan protects switch from impacts & accidental activation
- 20 gauge zinc-plated steel pan
- 2" diameter mounting hole

Part No.	Description	Wt. (lbs.)	Cat.
<b>SW911</b>	Switch, Toggle, 12V (2) Blade Terminals and Recessed Panel Mount	0.12	639 (N)
<b>SW9111</b>	Switch, Toggle, 12V (2) Blade Terminals	0.12	639 (N)

# Circuit Breakers

## Hi-Amp Circuit Breakers



- For cranes, dump hoists, liftgates, plows, spreaders, etc.
- 1/4-28 silver plated studs and stainless steel nuts with rubber boots
- Waterproof

Part No.	Amps	Description	Cat.
CB30PB	30	Manual Reset, Push-to-Trip	560 (N)
CB50	50	Auto Reset	560 (N)
CB50PB	50	Manual Reset, Push-to-Trip	560 (N)
CB60	60	Auto Reset	560 (N)
CB60PB	60	Manual Reset, Push-to-Trip	560 (N)
CB80PB	80	Manual Reset, Push-to-Trip	560 (N)
CB90PB	90	Manual Reset, Push-to-Trip	560 (N)
CB100	100	Auto Reset	560 (N)
CB100PB	100	Manual Reset, Push-to-Trip	560 (N)
CB120PB	120	Manual Reset, Push-to-Trip	560 (N)
CB150	150	Auto Reset	560 (N)
CB150PB	150	Manual Reset, Push-to-Trip	560 (N)
CB200PB	200	Manual Reset, Push-to-Trip	560 (N)
CB1	-	Terminal Adapter for Larger Eyelets	520 (N)

## Hi-Amp Large Frame Circuit Breakers

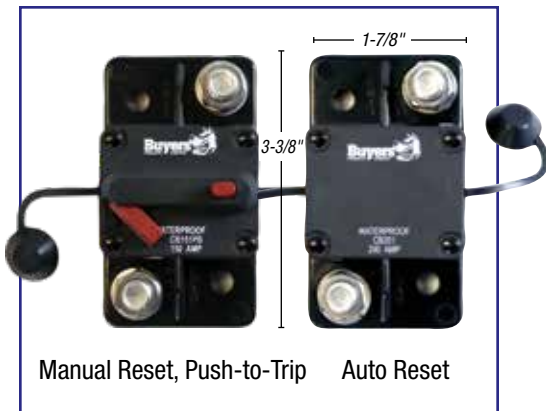

- For cranes, dump hoists, liftgates, plows, spreaders, etc.
- 3/8" silver plated steel studs and nuts with rubber boots provide additional clearance for heavy gauge connectors
- Waterproof

Part No.	Amps	Description	Cat.
CB151	150	Auto Reset	560 (N)
CB151PB	150	Manual Reset, Push-to-Trip	560 (N)
CB201	200	Auto Reset	560 (N)
CB201PB	200	Manual Reset, Push-to-Trip	560 (N)
CB251PB	250	Manual Reset, Push-to-Trip	560 (N)
CB300*	300	Auto Reset	560 (N)

## Hi-Amp Panel Mount Circuit Breakers

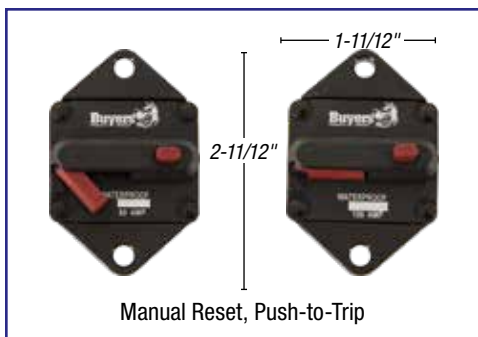

- For cranes, dump hoists, liftgates, plows, spreaders, etc.
- Panel mount with 1/4-28 stainless steel studs
- Waterproof

Part No.	Amps	Description	Cat.
CB62PB	60	Manual Reset, Push-to-Trip	560 (N)
CB102PB	100	Manual Reset, Push-to-Trip	560 (N)
CB152PB	150	Manual Reset, Push-to-Trip	560 (N)
CP202PB	200	Manual Reset, Push-to-Trip	560 (N)



## Counter Clockwise Rotation Motor



Part No.	Description	Cat.
<b>M3100</b>	12 Volt D.C. Motor Less Drive End, Tang Shaft	639 (N)

## Bi-Rotational Motor



Part No.	Description	Cat.
<b>M3300</b>	12 Volt, DC Motor	639 (N)

## Clockwise Rotation Motor with Spline Output Shaft



Part No.	Description	Cat.
<b>M3400</b>	12 Volt D.C. Motor with 9-Spline Output Shaft	639 (N)

## Canister Type Solenoid



- Push for ON, Spring return for off
- 5/16"-24 Thd. terminals
- 1" diameter mounting hole
- Fits through 1/4" panel thickness
- Button extends 1" above faceplate

Part No.	Description	Cat.
<b>B63322</b>	Solenoid - Canister	639 (N)

## Continuous Duty 12 Volt Plastic Case Solenoid (Insulated)



- Waterproof, sealed design
- 11/32" holes, 3" on center
- 5/16"-24 Thd. terminals
- 10-32 coil terminals

Part No.	Description	Cat.
<b>1306317</b>	Solenoid, 12V, Motor Relay, Continuous	639 (N)
<b>1304719</b>	Solenoid, 12V, 150 AMP, Motor Relay, Intermittent	639 (N)

## Intermittent 12 Volt Plastic Case Solenoid (Insulated)



- 5/16"-24 Thd. terminals
- 9/32" x 25/64" holes, 27/64" on center

Part No.	Description	Cat.
<b>1306070</b>	Intermittent-duty, +12V to Activate	639 (N)
<b>1306300</b>	Intermittent-duty, GND to Activate	639 (N)



## Solenoid Switch Kit



- 150 amp, grounded coils
- Alloy silver-plated contact material, intermittent-duty
- Ideal for any application that requires reversing motion (truck winch, tarp systems, boat lifts, RV slide-out, RV leveling systems)

Part No.	Description	Cat.
<b>1306600</b>	Solenoid, grounded, Reversing Polarity	639 (N)
<b>3014186</b>	Plastic Cover for 1306600	639 (N)

## Grounded 12 Volt Steel Case Solenoid (Insulated)

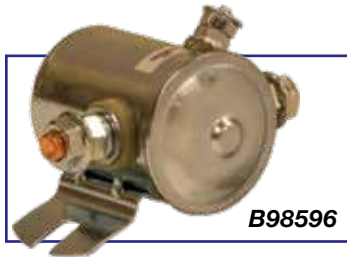

- Continuous-duty
- 5/16"-24 thread terminals
- 12 volts applied to center terminals activates solenoid

Part No.	Description	Cat.
<b>B98596</b>	Solenoid-Steel Case with Slots	639 (N)



- Continuous-duty
- 5/16"-24 thread terminals
- 29/32" x 25/64" holes, 27/64" on center
- Ground connection applied to center terminal activates solenoid

Part No.	Description	Cat.
<b>1306505</b>	Solenoid, Steel, Ground-Activate	639 (N)

## 12 Volt Steel Case Solenoid (Insulated)



- Continuous-duty
- 5/16"-24 thread terminals
- Ground connection applied to center terminal activates solenoid
- Compares to Cole-Hersee® #24059

Part No.	Description	Cat.
<b>1306515</b>	Solenoid, Steel, 12V, Continuous Duty	639 (N)

## Clockwise Rotation Motor



Part No.	Description	Cat.
<b>M3200</b>	12 Volt D.C. Motor Less Drive End Tang Shaft	639 (N)



## Hour Meter



- Low power, low cost reliable hour meter with quartz timing
- Compact, tamper proof meter is sealed against moisture and dirt
- Mechanical counter requires no battery

Part No.	Description	Cat.
<b>B40B45</b>	10-80V DC Hour Meter, 2.75" Diameter x 1.875" Deep	630 (N)

**Compact, tamper proof meter is sealed against moisture and dirt.**

## Master Battery Isolator Switch



- Rated 100 amp continuous, 500 amp surge at 12 volts
- Four 3/16" diameter mounting holes
- Includes water-resistant cover and key

Part No.	Description	Cat.
<b>6391200</b>	Master Battery Disconnect Switch	639 (N)
<b>6391201</b>	Replacement Key for 6391200	639 (N)

## Dual Battery Isolator Switch



- 1000 amp surge/300 amp continuous for 5 seconds
- 12-28 VDC
- IP54 rated
- Silver plated contacts

Part No.	Description	Cat.
<b>6391050</b>	Dual Battery Isolator Switch, 300A	639 (N)

## Locking Battery Disconnect Switch



- 2500 amp surge/250 amp continuous for 5 seconds
- 12-24VDC
- Complies with OSHA 1910.147 lock-out/tag-out

Part No.	Description	Cat.
<b>6391005</b>	Battery Disconnect Switch, Dual, 250A	639 (N)

# Battery Bolt Adapters and Fuse Holders

## Brass Battery Bolt Adapters, Bulk

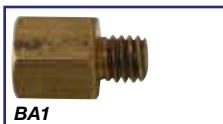

- Organize and protect battery connections
- Reduce corrosion of battery and connections
- Reduce warranty claims
- Replaces standard battery bolts
- Attach lights, backup alarms, lift gates, plows, spreaders, winches, etc.

Part No.	Description	Cat.
 BA1	Bolt, Brass, Side Terminal, 3/8-16	639 (N)

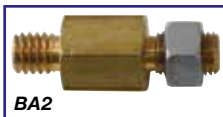

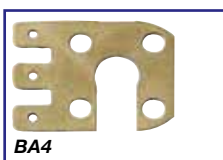

Part No.	Description	Cat.
 BA2	Bolt, Brass, Side Terminal, 3/8-24	639 (N)



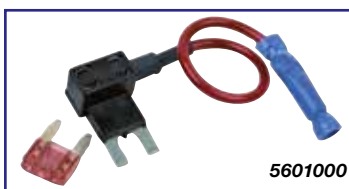

Part No.	Description	Cat.
 BA4	Bolt, Brass, Terminal Tap & Ground, Side Mount Bulk	639 (N)

## Dual Fuse Holders

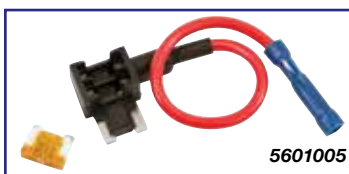

Part No.	Description	Cat.
 5601000	Dual Fuse Holder Dual ATM Mini Fuse Holder, 10 Amp Main, 5 Amp Added	639 (N)
Turns one fuse slot into two. Fuse not included.		



Part No.	Description	Cat.
 5601005	Dual Fuse Holder Dual ATM Type Low Profile, 10 Amp Main, 5 Amp Added	639 (N)
Turns one fuse slot into two. Fuse not included.		



Part No.	Description	Cat.
 5601107	Dual Fuse Holder Dual ATR Type Micro, 10 Amp Main, 5 Amp Added	639 (N)
Turns one fuse slot into two. Fuse not included.		

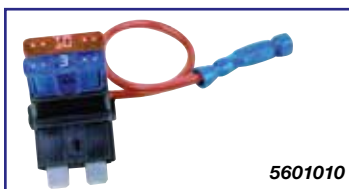

Part No.	Description	Cat.
 5601010	Dual Fuse Holder Dual ATO/ATC Fuse Holder, 10 Amp Main, 5 Amp Added	639 (N)
Turns one fuse slot into two. Fuse not included.		



# Junction Boxes, Fuse Block, Battery Protector & Electric Converter

## Junction Boxes



- Consolidates your truck's electrical wiring

Part No.	Description	Cat.
 5601100	Polypropylene Electrical Junction Box with 7 Terminals, 8-3/8"L x 3-7/8"W x 2-3/8"T	639 (N)



Part No.	Description	Cat.
 5601101	ABS Electrical Junction Box with 7 Color-Coded Terminals, 8"L x 3-1/4" W x 2-3/16" T	639 (N)

Color-coded terminals help you stay organized.

## 6-Way Fuse Block With Cover



- For use with ATC/ATO blade-type fuses (fuses not included)
- 25 amps max per circuit with 150 amp max per block
- Includes two tin-plated copper 10-32 studs and six tin-plated copper terminal screws
- Clear polycarbonate removable cover for easy viewing

Part No.	Description	Cat.
 5601006	6-Way Fuse Block with Cover	639 (N)

## Low Voltage Disconnect Timer



- Automatically shuts off power to accessories to preserve engine starting battery capacity
- 12 volt 20 amp solid state
- Over current protection
- 4-wire terminal
- Compact size
- Durable metal case

Part No.	Description	Cat.
5601012	Low Voltage Disconnect Timer	639 (N)

## Electric Converter



- Convert 110C AC to 12V DC
- 5A output
- 1/4" MQD(-), 1/4" FQD(+)
- Perfect for showroom displays

Part No.	Description	Cat.
3023432	Electric Adapter, Convert 110 AC to 12VDC, 5A Output, 1/4" MQD(-), 1/4" FQD(+)	639 (N)





## DOT Lighting Display



Part No.	Description	Cat.
3047422	DOT Lighting Display	991 (N)

## DOT Lighting Display



Part No.	Description	Cat.
3047423	DOT Lighting Display	991 (N)

## Warning Lights Display

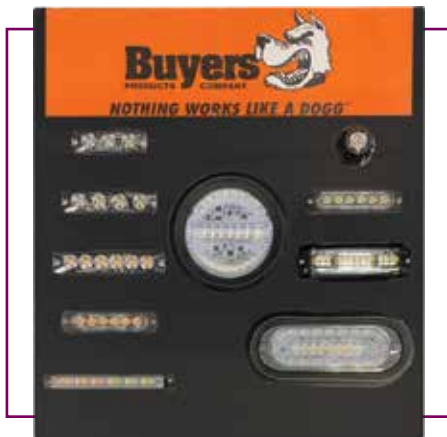

Part No.	Description	Cat.
3047424	Warning Lights Display with Converter	991 (N)

# Plow Light Counter Displays

## Low Profile LED SAM Plow Light Counter Display



Part No.	Description	Cat.
3044830	Low Profile LED SAM Plow Light Counter Display	991 (N)

## LED SAM Plow Light Counter Display



Part No.	Description	Cat.
3044831	LED SAM Plow Light Counter Display	991 (N)



## Work Lights Display



Part No.	Description	Cat.
3037650	Work Lights Display with, 1492290, 1492115, 1492113, and 1492135	991 (N)

## Mini Light Bars Display



Part No.	Description	Cat.
3050254	Mini Light Bars Display with, 8891042 and 8891060	991 (N)



# Lighting Regulations

**IMPORTANT NOTE:** Every lamp, reflex reflector, and conspicuity treatment (device) must be permanently attached in the location specified below and must comply with all applicable requirements prescribed for it by FMVSS/CMVSS 108. The face of any device on the front/rear and sides should be, respectively perpendicular and parallel to vehicle centerline, unless it is photometrically certified at installation angle. No part of the vehicle shall prevent any device from meeting its prescribed requirements unless an auxiliary device meeting all prescribed requirements is installed.

In Canada: Manufacturers and importers of vehicles must have the proper certification test records demonstrating compliance of lighting components with all prescribed requirements.

## BASIC EQUIPMENT REQUIRED ON ALL TRUCKS, BUSES & MPVs

DESCRIPTION				MANDATORY REQUIREMENTS			
Area	Equipment	(SAE Lens Coding)	Functional Purpose	Minimum Required	Color	Location	Height mm (in.) from the ground
1	Headlamps - Lower Beam Attention: US: "DOT" lettering required on lens Attention: US & Canada: light source code required on lens	(H, HR)	Forward road illumination	2	White	On the front - symmetrical - as far apart as practicable (If 4 lamp system - outboard or above upper beams)	560-1370 (22-54)
	Headlamps - Upper Beam Attention: US: "DOT" lettering required on lens Attention: US & Canada: light source code required on lens	(H, HR)	Forward road illumination	2	White	On the front - symmetrical ( If 4 lamp system - inboard or below lower beams)	560-1370 (22-54)
	Parking Lamps-Attention: Required only on vehicles less than 2032mm wide	(P)	Indicate parked vehicle	2	White or Yellow	Front - symmetrical - as far apart as practicable	380-1530 (15-60)
	Daytime Running Lamps - Attention: for Canada required, for US optional. Attention: for US, "DRL" lettering required on lens if device is not headlamp	(Y2)	Indicate in-use vehicle	2	White or Yellow	Front - symmetrical - as far apart as practicable	380 (15) minimum Maximum depends on type of DRL
	Front Turn Signal/Hazard Warning Lamps	(I)	Indicate direction of turn / identify disabled vehicle	2	Yellow	Front - symmetrical - as far apart as practicable	380-2110 (15-83)
2	Front Clearance Lamps- Attention: Required for vehicles 2032mm wide or wider *photometrically certified at installation angle	( P2, PC* or P3*,PC2)	Show vehicle's width	2	Yellow	At widest point - symmetrical - on the front or near the front - facing forward	As high as practicable
3	Front Identification Lamps (ID)	(P2 or P3)	Indicate presence of a wide vehicle	Exactly 3	Yellow	on the front - center - horizontally spaced 150 mm (6 in.) to 300 mm (12 in.) apart	As high as practicable or on top of cab
4a	Front Side Marker Lamps *photometrically certified at installation angle	( P2, PC* or P3 ,PC2*)		2	Yellow	Each side at front - as far forward as practicable	380 (15) minimum
4b	Front Side Reflex Reflectors	(A)	Front and Rear side marker lamps / side	2	Yellow	At front - symmetrical - as far forward as practicable - facing sideward	380-1530 (15-60)
5a	Rear Side Marker Lamps ** *photometrically certified at installation angle	(P2, PC* or P3, PC2*)	reflex reflector indicate vehicle's presence and length	2	Red	Each side at rear - as far back as practicable	380 (15) minimum
5b	Rear Side Reflex Reflectors*** not required on Truck Tractors	(A)		2	Red	Each side at rear - as far back as practicable - facing sideward	380-1530 (15-60)
6	Rear Clearance Lamps Attention: Required for vehicles 2032mm wide or wider, but not required on Truck Tractors *photometrically certified at installation angle	(P2, PC* or P3, PC2*)	Show vehicle's width - MAY NOT be combined with tail lamps	2	Red	At widest point - symmetrical - on the rear or near the rear - facing rearward	As high as practicable-may be lower only if rear ID lamps are at the top
7	Rear Identification Lamps (ID) Attention: Required for vehicles 2032mm wide or wider, but not required on Truck Tractors	(P2 or P3)	Indicate presence of a wide vehicle	Exactly 3	Red	Rear - center - horizontally spaced 150 mm (6 in.) to 300 mm (12 in.) apart, facing rearward	in Canada : at the top - maybe lower if door header narrower than 25mm in USA: as high as practicable

Area	Equipment	(SAE Lens Coding)	Functional Purpose	Minimum Required	Color	Location	Height mm (in.) from the ground
8	Tail Lamps	(T)	Indicate vehicle's presence and width	2	Red	On the rear - symmetrical - as far apart as practicable	380-1830 (15-72)
	Stop Lamps	(S)	Indicate braking	2	Red	On the rear - symmetrical - as far apart as practicable	380-1830 (15-72)
	Rear Turn Signal/Hazard Warning Lamps	(I)	Indicate direction of turn/ identifies disabled veh.	2	Red or Yellow	On the rear - symmetrical - as far apart as practicable	380-2110 (15-83)
	Rear Reflex Reflectors	(A)	Show vehicle's presence and width	2	Red	On the rear - symmetrical - as far apart as practicable - facing rearward	380-1530 (15-60)
9	Backup Lamp	(R)	Illuminate ground behind the vehicle and alert road users	1	White	Rear	No requirement
10	License Plate Lamp(s)	(L)	Illuminates license plate	1	White	On the rear - above or at the sides of license plate	No requirement
11	Center High Mounted Stop Lamp Attention: Required for vehicles less than 2032mm wide and 4536kg	(U3)	Indicates braking	Minimum 1	Red	On the rear - centerline of the vehicle	860 (34) minimum

## ADDITIONAL EQUIPMENT FOR SPECIFIC VEHICLES

### VEHICLES 9.1 m (30 ft.) LONG OR LONGER

DESCRIPTION				MANDATORY REQUIREMENTS			
Area	Equipment	(SAE Lens Coding)	Functional Purpose	Quantity	Color	Location	Height mm (in.) from the ground
12a	Intermediate Side Marker Lamps	(P2 or PC)	Indicate presence of a long vehicle	Minimum 2	Yellow	Each side near center	380 (15) minimum
12b	Intermediate Side Reflex Reflectors	(A)	Indicate presence of a long vehicle	Minimum 2	Yellow	Each side near center - facing sideward	380-1530 (15-60)

## TRUCK TRACTORS

DESCRIPTION		MANDATORY REQUIREMENTS					
Area	Conspicuity Treatment	DOT Code	Quantity	Color	Location	Height	Options
13	Rear Upper Body Marking	DOT-C, DOT-C2, DOT-C3, or DOT-C4	Exactly 2 pairs of 300mm long strips	White	Rear upper corners of cab - facing rearward	As high as practicable excluding fairings	
14	Rear Marking	DOT-C, DOT-C2, DOT-C3, or DOT-C4	Exactly 2 sections of min. 600mm each	Red/ White	Rear - facing rearward - on fenders, on mud flaps brackets, or within 300mm below of the top of mud flaps	As horizontal as practicable and not higher than 1525 mm from the ground	If mud flaps not used - on the cab or frame mounted brackets

# Lighting Regulations

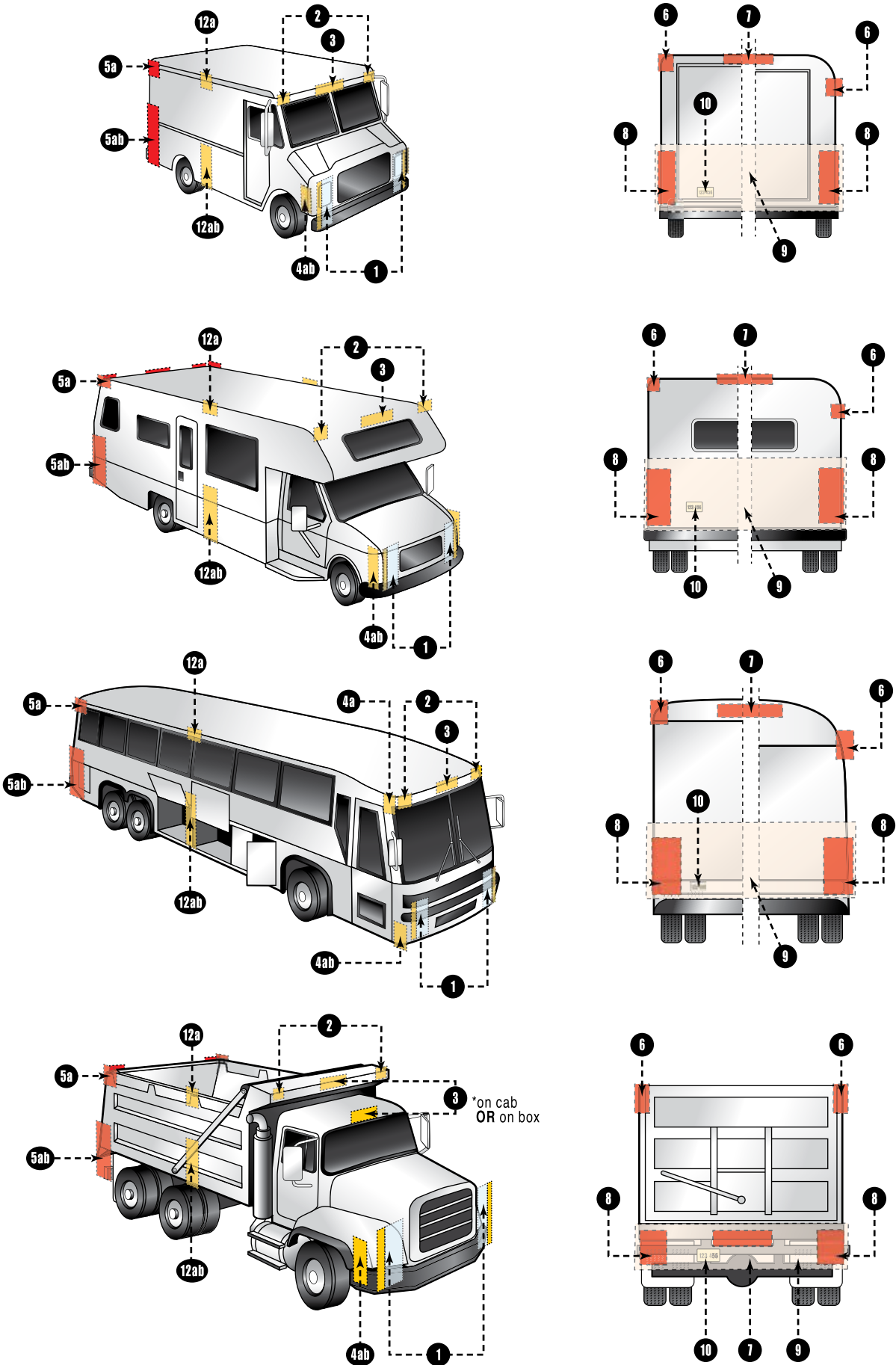

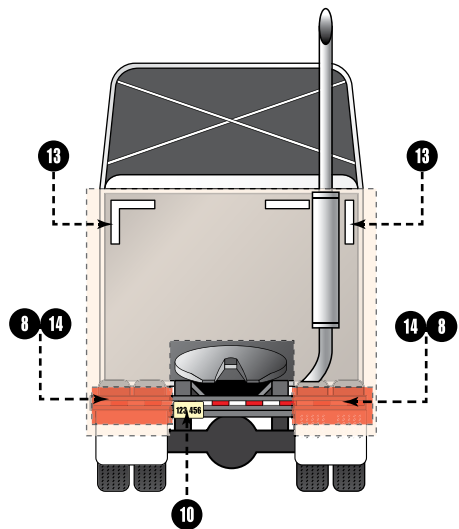
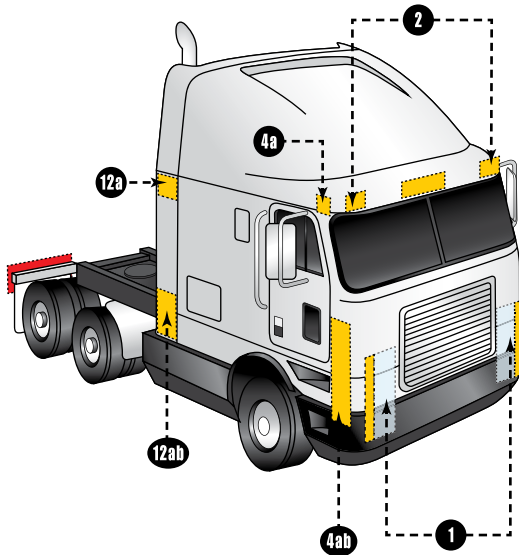
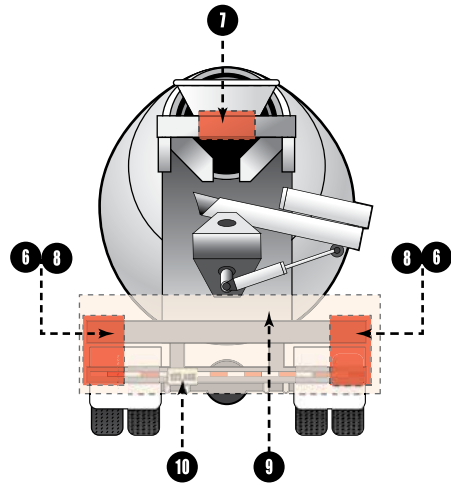
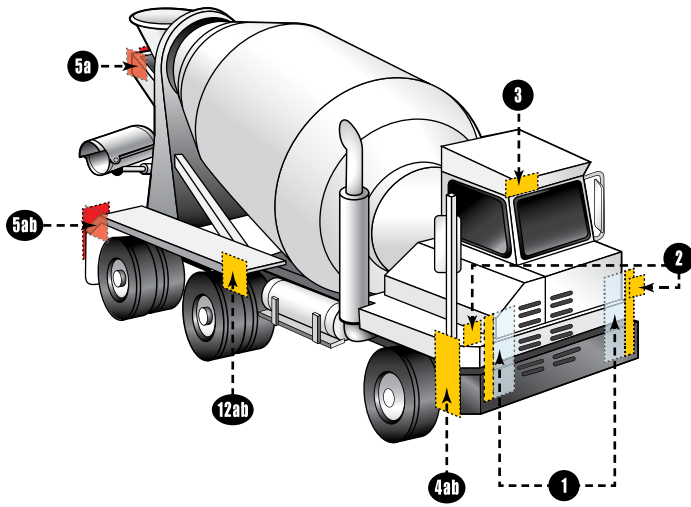
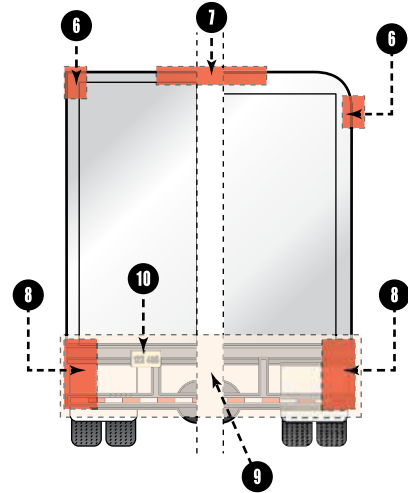
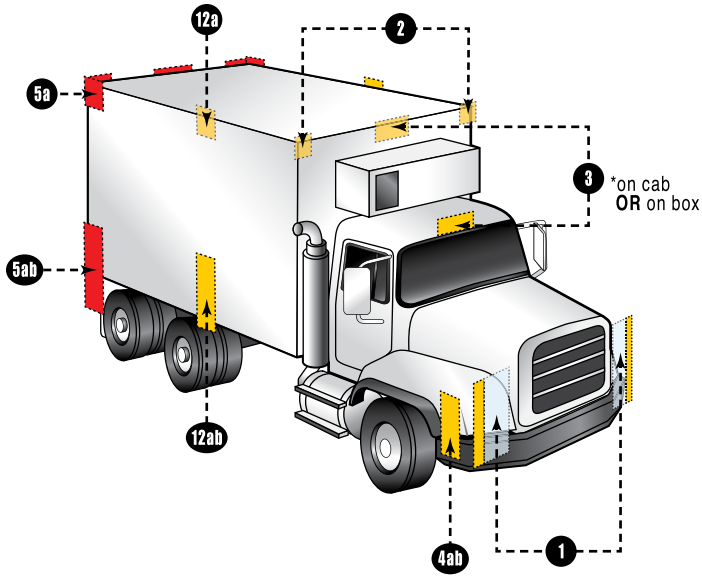



# Lighting Regulations

## TRAILERS: FEDERAL LIGHTING EQUIPMENT LOCATION REQUIREMENTS

IMPORTANT NOTE: Every lamp, reflex reflector, and conspicuity treatment (device) must be permanently attached in the location specified below and must comply with all applicable requirements prescribed for it by FMVSS/CMVSS 108. The face of any device on the front/rear and sides should be, respectively perpendicular and parallel to vehicle centerline, unless it is photometrically certified at installation angle. No part of the vehicle shall prevent any device from meeting its prescribed requirements unless an auxiliary device meeting all prescribed requirements is installed.

In Canada: Manufacturers and importers of vehicles must have the proper certification test records demonstrating compliance of lighting components with all prescribed requirements.

### BASIC EQUIPMENT REQUIRED ON ALL TRAILERS

DESCRIPTION				MANDATORY REQUIREMENTS			
Area	Equipment	(SAE Lens Coding)	Functional Purpose	Quantity	Color	Location	Height mm (in.) from the ground
1	Tail Lamps	(T)	Indicate vehicle's presence and width	Minimum 2	Red	On the rear - symmetrical - as far apart as practicable	380-1830 (15-72)
	Stop Lamps	(S)	Indicate braking	Minimum 2	Red	On the rear - symmetrical - as far apart as practicable	380-1830 (15-72)
	Rear Turn Signal Lamps	(I)	Indicate direction of turn	Minimum 2	Red or Yellow	On the rear - symmetrical - as far apart as practicable	380-2110 (15-83)
	Rear Reflex Reflectors	(A)	Indicate vehicle's presence and width	Minimum 2	Red	On the rear - symmetrical - as far apart as practicable - facing rearward	380-1530 (15-60)
2	License Plate Lamp(s)	(L)	Illuminates license plate	Minimum 1	White	On the rear - above or at the sides of license plate	No requirement
3	Rear Side Marker Lamps *photometrically certified at installation angle	(P2, PC* or P3, PC2*)	Front and rear side marker lamps / side reflex reflectors indicate vehicle's presence and length	Minimum 2	Red	Each side at rear - as far back as practicable	380-1530 (15-60) no max. for veh. under 2.032m(80") wide
	Rear Side Reflex Reflectors	(A)		Minimum 2	Red	Each side at rear - as far back as practicable facing sideward	380-1530 (15-60)
4a	Front Side Marker Lamps * photometrically certified at installation angle	(P2, PC* or P3, PC2*)		Minimum 2	Yellow	Each side at front - as far forward as practicable	380 (15) minimum
4b	Front Side Reflex Reflectors	(A)		Minimum 2	Yellow	Each side at front - as far forward as practicable facing sideward	380-1530 (15-60)

### ADDITIONAL EQUIPMENT FOR TRAILERS EXCEEDING THE FOLLOWING PARAMETERS

#### LENGTH 9.1 m (30 ft.) OR LONGER

DESCRIPTION				MANDATORY REQUIREMENTS			
Area	Equipment	(SAE Lens Coding)	Functional Purpose	Quantity	Color	Location	Height mm (in.) from the ground
5a	Intermediate Side Marker Lamps	(P2 or P3)	Indicate presence of a long vehicle	Minimum 2	Yellow	Each side near center - facing sideward	380 (15) minimum
5b	Intermediate Side Reflex Reflectors	(A)	Indicate presence of a long vehicle	Minimum 2	Yellow	Each side near center - facing sideward	380-1530 (15-60)

#### WIDTH 2.032 m (80 in.) OR WIDER

DESCRIPTION				MANDATORY REQUIREMENTS			
Area	Equipment	(SAE Lens Coding)	Functional Purpose	Quantity	Color	Location	Height
6	Rear Clearance Lamps * photometrically certified at installation angle	(P2, PC* or P3, PC2*)	Show vehicle's width - MAY NOT be combined with tail lamps	Minimum 2	Red	At widest point - symmetrical - on the rear or near the rear - facing rearward	As high as practicable - may be lower only if ID lamps are at the top

## TRAILERS: FEDERAL LIGHTING EQUIPMENT LOCATION REQUIREMENTS

IMPORTANT NOTE: Every lamp, reflex reflector, and conspicuity treatment (device) must be permanently attached in the location specified below and must comply with all applicable requirements prescribed for it by FMVSS/CMVSS 108. The face of any device on the front/rear and sides should be, respectively perpendicular and parallel to vehicle centerline, unless it is photometrically certified at installation angle. No part of the vehicle shall prevent any device from meeting its prescribed requirements unless an auxiliary device meeting all prescribed requirements is installed.

In Canada: Manufacturers and importers of vehicles must have the proper certification test records demonstrating compliance of lighting components with all prescribed requirements.

Area	Equipment	(SAE Lens Coding)	Functional Purpose	Quantity	Color	Location	Height mm (in.) from the ground
7	Rear Identification Lamps	(P2 or P3)	Indicate presence of a wide vehicle	Exactly 3	Red	On the rear - center, facing rearward - horizontally spaced 150 mm (6 in.) to 300 mm (12 in.) apart	in Canada : at the top - maybe lower if door header narrower than 25 mm in USA: as high as practicable
8	Front Clearance Lamps * photometrically certified at installation angle	(P2, PC* or P3, PC2*)	Show vehicle's width	Minimum 2	Yellow	At widest point - symmetrical - as far forward as practicable - facing forward	As high as practicable

## WIDTH 2.032 m (80 in.) OR WIDER AND GVWR 4536 kg (10,000 lb.) OR MORE

DESCRIPTION		MANDATORY REQUIREMENTS					
Area	Conspicuity Treatment	DOT Coding	Quantity	Color	Location	Height	OPTIONS
9	Rear Upper Body Marking	DOT-C, DOT-C2, DOT-C3, or DOT-C4	Exactly 2 pairs of 300mm long strips	White	On the rear upper corners - facing rearward	At the top	Reflex reflectors may not be required if they are replaced, in their required location, with conspicuity treatment  Optional in Canada Rear lower body and side conspicuity treatment may also be solid white, solid yellow, or white and yellow.
10	Bumper Bar Marking		Continuous	Red/White	On the rear bumper bar's horizontal element - full width - facing rearward	No requirement	
11	Rear Lower Body Marking		Continuous	Red/White see options	On the rear - full width of the vehicle - facing rearward	As horizontal as practicable and as close as practicable to the range of 375 to 1525 mm from the ground	
12	Side Marking		see location	Red/White see options	Each side - facing sideward - continuous, or evenly spaced over minimum of 50% of length, starts and ends as close to the front and rear or vehicle as practicable	As horizontal as practicable and as close as practicable to the range of 375 to 1525 mm from the ground	

# Lighting Regulations

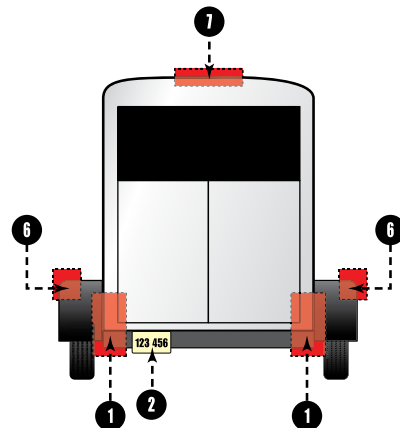
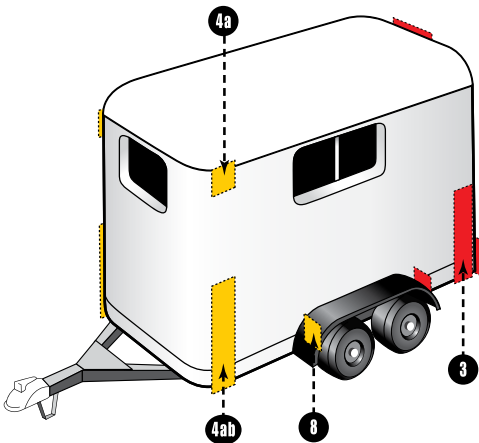
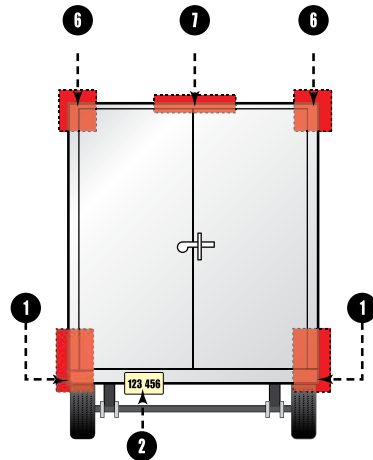
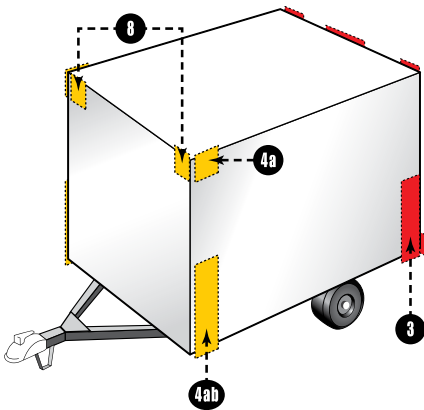
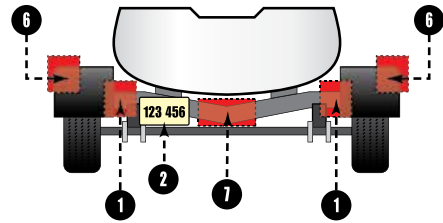
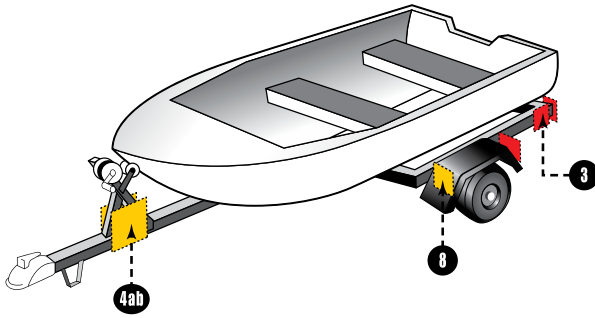
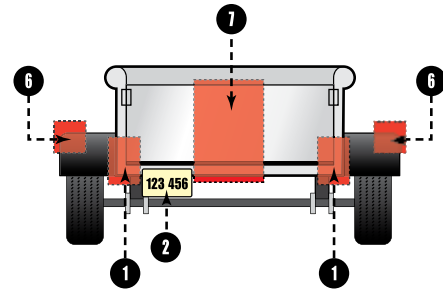
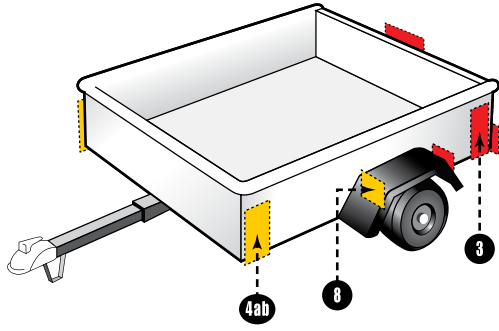

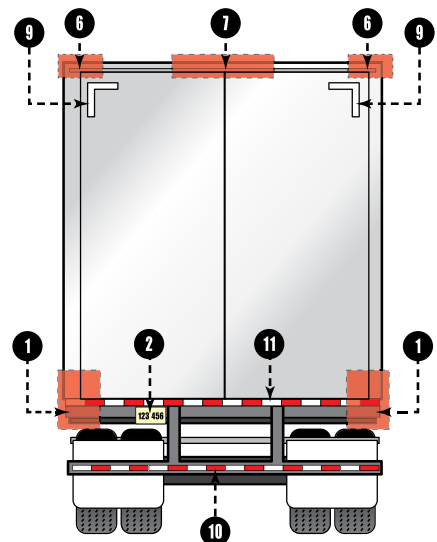
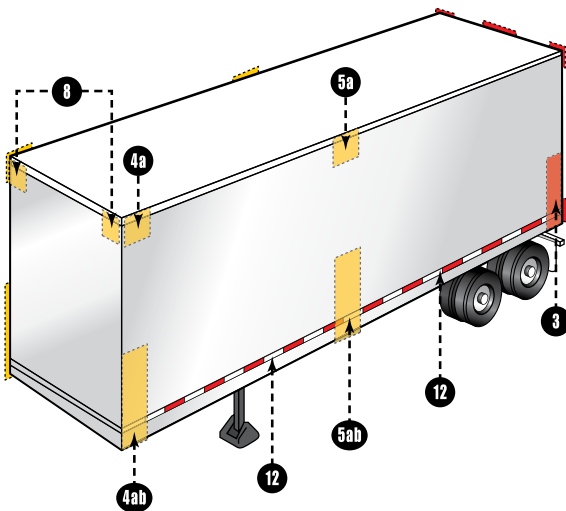
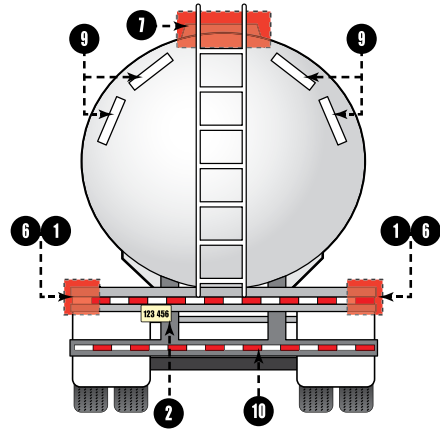
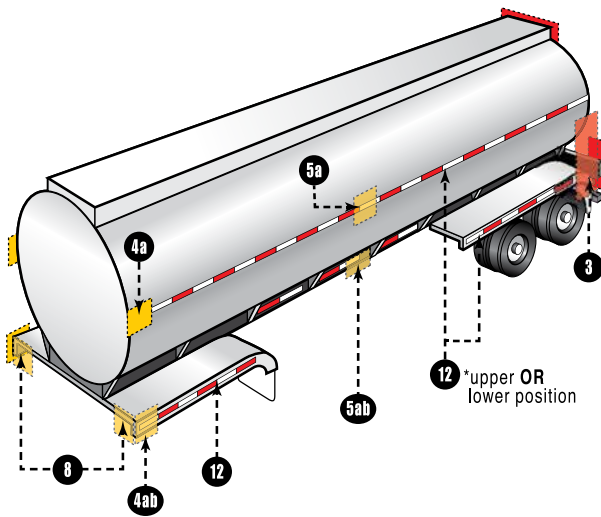
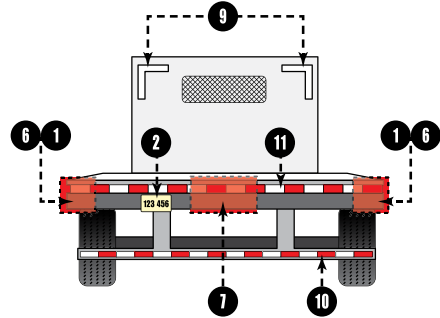
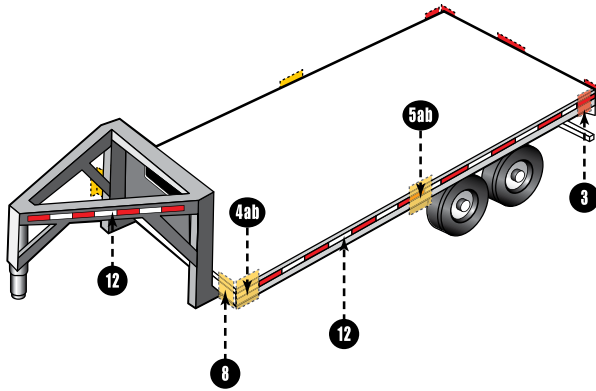
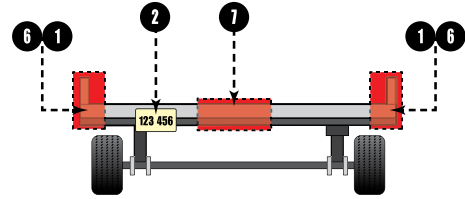
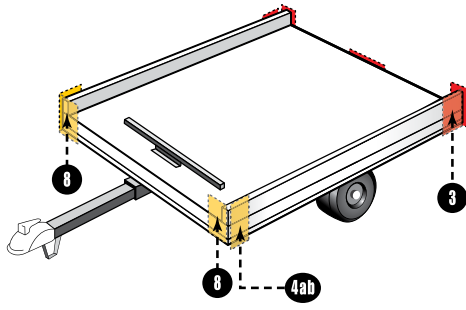



# Industry Glossary

---

**AISI:** American Iron and Steel Institute

**BHN:** Brinell Hardness Number - commonly used to define the hardness of materials like metals and alloys by measuring the force needed to cause an indentation.

**CA13 rating:** specifies minimum brightness for amber colored lights

**DOT:** Department of Transportation - the agency dealing with regulations concerning both the manufacture and operation of motor vehicles and equipment

**FMVSS 108:** Federal Motor Vehicle Safety Standard regulating all type, location, and performance requirements for automotive lighting, signaling and reflective devices

**FMVSS 571.106:** DOT specs for air push lock fittings on mobile applications

**FSD:** Full scale deflection

**GPM:** Gallons per minute

**HDPE:** High Density Polyethylene

**HG:** Inches of Mercury - vacuum

**HRPO:** Hot rolled, Pickled and oiled pertaining to steel treatment

**ICC:** Interstate Commerce Commission - the former federal agency that regulated requirements for motor carriers

**JIC:** Joint Industry Committee - the organization set up to standardize hydraulic fitting specifications and symbols

**LED:** Light Emitting Diode – two-lead semiconductor light source that emits light when activated

**Lumens:** A measure of brightness in which one lumen is equal to the light of a light candle from one foot away

**MBS:** Minimum Breaking Strength - force required to make the lifting equipment fail or yield, also known as the Minimum Breaking Load (MBL).

**MGTW:** Maximum Gross Trailer Weight - The largest weight of both trailer and its contents that can be safely towed by a coupling device

**Micron:** Micrometer = .001mm or .000039 inch equal to 1 thousandth of a millimeter

**MVL:** Maximum Vertical Load - The maximum recommended static vertical load (down) that can be applied to a coupling device for safe operation.

**NPSF:** National Pipe Female Swivel

**NPSM:** National Pipe Swivel Male

**NPT:** National Pipe Thread

**NPTF:** National Pipe Thread Fine

**PSI:** Pounds per square inch

**PTO:** Power Take off Option

**RPM:** Revolutions per minute

**SAE:** Society of Automotive Engineers – set standards for automotive equipment including lighting and towing

**SAE J585:** Standards for tail lamps

**SAE J845:** Standards for optical warning devices for authorized emergency, maintenance and service vehicles

**SAE J994:** Standards for back-up alarms

**SST:** Stainless Steel

**TFT LCD:** Thin-Film-Transistor Liquid-Crystal Display

**TPI:** Threads per inch

**UHMW:** Ultra High Molecular Weight – highest density polyethylene

**UNF:** Unified National Fine - thread standard for bolts, nuts and fasteners

**VDC:** Voltage Direct Current - measurement in a DC system

**WLL:** Working Load Limit - maximum working load designed by the manufacturer

**WOG:** Water, oil and gas

**Class 1:** Warning lights are the brightest and primarily reserved for emergency vehicles or other vehicles that may need to demand right of way, warn of an emergency situation or work highly trafficked roadways

**Class 2:** Warning lights are geared for utility trucks that could be on or off road, but need to provide a significant level of movement notification













**SAE J845 and J595:** Professional, industry standards for warning lights. Include guidelines for flash timing, photometry, color and environmental requirements (SAE J845 applies to 360 degree beacons and lightbars; SAE J595 applies to directional lights)

**California Title 13:** State of California has additional requirements that apply specifically to warning lights

**PC Rated:** Light beam emitted spread out 90 degrees to either side of its centerline for a total of 180 degrees of coverage

**IP Rating (Ingress Protection):** A two-digit number that follows the code letters "IP" - the first digit represents protection against ingress of solid objects, the second digit represents protection against ingress of liquids (X represents that protection level was not formally tested for that category). The larger the value of each digit, the greater the protection

## ICON DEFINITION

-  The light beam emitted from this light spreads out 90 degrees to either side of its centerline for a total of 180 degrees of coverage
-  Ingress protection from solids is rated at a 6 meaning that it allows no ingress of dust. Ingress protection from liquids is rated at a 5 meaning that it has protection against low pressure jets of water
-  Ingress protection from solids is rated at a 6 meaning that it allows no ingress of dust. Ingress protection from liquids is rated at a 6 meaning that it has protection against high pressure jets of water
-  Ingress protection from solids is rated at a 6 meaning that it allows no ingress of dust. Ingress protection from liquids is rated at a 7 meaning that it has protection against immersion in water between 15cm to 1m deep for 30 minutes
-  Ingress protection from solids is rated at a 6 meaning that it allows no ingress of dust. Ingress protection from liquids is rated at an 8 meaning that it has protection against immersion in water under pressure for long periods
-  Ingress protection from solids has not been formally tested. Ingress protection from liquids is rated at a 6 meaning that it has protection against high pressure jets of water
-  Ingress protection from solids has not been formally tested. Ingress protection from liquids is rated at a 7 meaning that it has protection against high pressure jets of water
-  Ingress protection from solids has not been formally tested. Ingress protection from liquids is rated at an 8 meaning that it has protection against immersion in water under pressure for long periods
-  Ingress protection from solids is rated at a 6 meaning that it allows no ingress of dust. Ingress protection from liquids is rated at an 9K meaning that it has protection against high temperature water jets
-  Meets the industry standards for warning lights to be rated SAE J595 Class 1
-  Meets the industry standards for warning lights to be rated SAE J845 Class 1
-  Meets the requirements that apply to warning lights in the state of California

# Warranty

---

## BUYERS PRODUCTS WARRANTY POLICY

(please see below for separate LED lighting policies)

Buyers Products warrants all products and hardware manufactured, and/or distributed by it (except those specified) to be free from defects in material and workmanship for a period of one (1) year from date of shipment. Parts must be properly installed and used under normal conditions. Any product which has been altered, including modification, misuse, accident, or lack of maintenance will not be considered under warranty. Normal wear is excluded. The sole responsibility of Buyers Products under this warranty is limited to repairing or replacing any part or part which are returned, prepaid, and are found to be defective by Buyers Products. Authorization from Buyers Products must be obtained before returning any part. No charges for transportation or labor performed on Buyers' products will be allowed under this warranty.

## LED LIGHTING

### 1-YEAR

Buyers Products Company warranties all **Rotating Beacons**, and **Incandescent products** to the original owner against defects in workmanship and material for a period of one (1) year from the date of purchase unless otherwise specified.

### 5-YEAR

Buyers Products Company warranties all **LED Strobe**, **LED Strip Lights**, **LED Tube Lights**, and **LED Work Light** products to the original owner against defects in workmanship and material for a period of five (5) years from the date of purchase unless otherwise specified.

### LIMITED LIFETIME

Buyers Products Company warranties all **DOT LED Lighting** products to the original owner against defects in workmanship and material for the lifetime of the product unless otherwise specified.

Buyers Products must review each warranty claim and reserves the right to offer a refund for the original sale price of the product or replace the defective light. The one (1) year warranty is non-transferable, applies to the original owner, and is subject to the following terms and conditions. The warranty will be void in cases of misuse, severe abuse, and failure to properly install the light. Breakage of the lens or housing, corrosion at the plug, wire wicking, voltage spikes, and product failure caused by road chemicals and acid type washes are not warrantable claims. This warranty gives you specific legal rights and you may also have other legal rights that vary from state to state.

PART NO.	PAGE NO.	PART NO.	PAGE NO.	PART NO.	PAGE NO.	PART NO.	PAGE NO.	PART NO.	PAGE NO.
1304719	127	1492237	16	5601023	118	5623000	105	5626191	29
1306070	127	1492238	21	5601025	118	5623001	105	5626201	96
1306300	127	1492260	22	5601026	118	5623050	85	5626206	97
1306317	127	1492261	22	5601032	118	5623112	85	5626208	98
1306505	128	1492262	22	5601033	118	5623113	85	5626209	98
1306515	128	1492263	22	5601100	131	5623122	85	5626210	97
1306600	128	1492265	22	5601101	131	5623123	85	5626211	97
1311100	35	1492281	23	5601107	130	5623316	105	5626310	101
1311103	35	1492282	23	5609000	109	5623317	105	5626311	101
1311110	35	1492283	23	5609001	109	5623413	80	5626324	101
1312000	34	1492284	23	5620250	81	5623414	80	5626325	101
1312100	34	1492285	23	5620250	82	5623423	80	5626352	30
1312200	35	1492290	11	5620250	83, 84, 85, 105	5623424	80	5626356	100
1492100	7	1493215	6	5620251	89, 92, 95, 97, 99, 100, 101, 102, 105	5623520	105	5626357	100
1492106	7, 19	3014186	128	5620350	30, 87, 88, 89, 90, 91, 92, 93, 95, 96, 97, 98, 105	5623521	105	5626432	68
1492107	7, 19	3014187	124	5620351	105	5623654	29	5626510	91
1492110	6	3014188	124	5620352	88, 91, 96, 105	5623711	85	5626520	93
1492111	6	3014193	35	5620353	105	5623712	85	5626521	93
1492112	6	3014194	35	5620354	105	5623750	29	5626550	91
1492113	6	3016342	131	5620355	87, 88, 90, 91, 93, 105	5623755	29	5626551	91
1492114	5	3023432	39	5620356	105	5623812	85	5626552	91
1492115	6	3024631	39	5621002	29, 124	5623822	85	5626553	91
1492116	6	3024632	39	5621010	104	5623856	28	5626700	94
1492117	17	3024633	39	5621012	104	5623957	28	5626734	94
1492118	19	3024634	39	5621534	103	5624050	30, 87, 88, 89, 95, 96, 99, 100	5626738	94
1492119	18	3024635	39	5621711	86	5624101	87	5627036	30
1492125	4	3024636	39	5621719	86	5624110	88	5627038	30
1492126	4	3024637	39	5621720	86	5624118	88	5627501	80
1492127	5	3024638	39	5621827	29	5624119	88	5627503	80
1492128	10	3024640	39	5621928	29	5624130	89	5627511	80
1492129	16	3024642	39	5622029	28	5624131	89	5627512	80
1492130	5	3024644	40	5622032	103	5624132	89	5627513	80
1492133	21	3025442	40	5622050	81	5624150	88	5627514	80
1492134	17	3026114	40	5622101	81	5624151	88	5627517	80
1492135	19	3026115	40	5622102	81	5624156	87	5627521	80
1492137	16	3026116	40	5622103	84	5624157	87	5627522	80
1492138	20	3029961	74	5622104	84	5624201	95	5627523	80
1492139	20	3032932	39	5622120	28	5624207	95	5627524	80
1492145	4	3032933	39	5622130	103	5624211	96	5627527	80
1492146	4	3034110	27	5622132	103	5624251	96	5627532	80
1492160	24	3034400	40	5622133	103	5624310	99	5627533	86
1492161	24	3035770	27	5622134	104	5624324	100	6391001	121
1492162	24	3035768	27	5622150	81	5624325	100	6391002	121
1492163	24	3035781	27	5622154	81	5624350	99	6391003	121
1492165	24	3035783	27	5622201	81	5624352	30	6391004	121
1492171	26	3035788	27	5622202	81	5624356	99	6391005	129
1492172	26	3035896	29	5622203	84	5624357	99	6391050	129
1492182	25	3037650	135	5622204	84	5624432	68	6391100	123
1492183	25	3042509	40	5622205	84	5624433	31	6391101	121, 123
1492184	25	3044830	134	5622205	84	5624872	29	6391102	123
1492185	25	3044831	134	5622250	81	5624973	29	6391103	123
1492190	11	3047422	133	5622254	81	5625074	29	6391104	123
1492191	21	3047423	133	5622304	84	5625111	94	6391105	123
1492193	18	3047424	133	5622436	29	5625115	93	6391106	123
1492194	12	3047424	133	5622505	82, 83	5625117	94	6391200	129
1492195	12	3047900	132	5622506	82, 83	5625175	29	6391201	129
1492196	11	3047901	132	5622512	82	5625215	98	6391204	41, 51, 122
1492197	9	3047902	132	5622514	82	5625276	28	6391205	41, 122
1492198	8	3048064	73	5622517	83	5625332	102	6391206	41
1492199	18	3048966	27	5622522	82	5625336	30	6391207	50, 51, 122
1492215	6	3048967	27	5622524	82	5625337	30	6391208	41, 122
1492220	17	3050254	135	5622525	82	5625338	30	6391209	41, 122
1492221	20	5601000	130	5622526	83	5625377	28	6391215	124
1492222	10	5601005	130	5622527	83	5625576	31	6391308	123
1492223	8	5601006	131	5622537	29	5626050	30	8882150	117
1492224	9	5601010	130	5622550	82	5626050	90, 91, 92, 93, 96, 97, 98, 100, 101	8883000	114
1492225	9	5601012	131	5622551	83	5626090	29	8883010	114
1492226	10	5601015	118	5622638	29	5626101	90	8883020	114
1492227	8	5601016	118	5622716	84	5626103	90	8883030	115
1492228	12	5601017	118	5622726	84	5626130	92	8883040	115
1492230	14	5601018	118	5622739	29	5626131	92	8883101	116
1492231	14	5601020	118	5622754	104	5626132	92	8883102	116
1492232	14	5601021	118	5622840	28	5626156	90	8883103	116
1492233	15	5601022	118	5622941	28	5626157	90	8883104	116
1492235	13							8883105	116
1492236	13								



## Numerical Index

PART NO.	PAGE NO.	PART NO.	PAGE NO.	PART NO.	PAGE NO.	PART NO.	PAGE NO.	PART NO.	PAGE NO.
8883106	116	8891132	59	8892205	53	8895400	49, 77	LB6183	112
8883108	116	8891135	59	8892206	53	8895404	49, 77	LB6183ALDT	112
8883110	117	8891144	106	8892207	53	8895551	49	LB6183SST	112
8883111	117	8891145	106	8892208	53	8895554	49	LB6303SST	113
8883116	117	8891150	106	8892209	53	8895556	49	LB6304SST	113
8883132	117	8891166	106	8892210	53	8895560	48	LB6305SST	113
8883165	117	8891167	106	8892225	53	56296144	29	LB663	111
8883182	117	8891168	106	8892230	52	56297145	29	LB663SL	111
8883210	115	8891169	106	8892231	52	88930243	38	LB663SST	111
8883215	117	8891177	107	8892232	52	88930492	38	LB8133	110
8890200	63	8891178	107	8892233	52	88930493	38	LB8443SST	108
8890202	63	8891200	65	8892234	52	88930603	38	LB8445SST	108
8890300	55	8891201	65	8892239	52	88930604	38	LB8663SST	108
8890301	55	8891215	65	8892240	52	88930605	38	LB8665SST	108
8890302	55	8891216	65	8892241	52	562109166	29	M3100	127
8890305	55	8891225	65	8892242	52	562133202	29	M3200	128
8890306	55	8891226	65	8892243	52	B210880	77	M3300	127
8890307	55	8891227	65	8892244	52	B40B45	129	M3400	127
8890308	55	8891325	65	8892245	52	B63322	127	PLB11SS	35
8890310	55	8891326	65	8892246	52	B98596	128	PLB12SS	35
8890320	55	8891327	65	8892247	52	BA0972	120	RL650A	76
8890321	55	8891400	58	8892248	52	BA1	130	SL40AR	69
8890400	53	8891401	58	8892249	52	BA102	120	SL41AR	69
8890401	53	8891402	58	8892250	52	BA107	120	SL475A	74
8890402	53	8891403	58	8892255	52	BA2	130	SL475R	74
8890403	53	8891404	58	8892300	55	BA4	130	SL480A	74
8890404	53	8891405	58	8892301	55	BSW002	125	SL500A	76
8890405	53	8891500	60	8892309	55	BSW90030	124	SL501A	74
8890406	53	8891501	60	8892320	55	CB1	126	SL502A	72
8890407	53	8891502	60	8892321	55	CB100	126	SL550ALP	70
8890408	53	8891505	60	8892325	55	CB100PB	126	SL551ALP	70
8890409	53	8891506	60	8892400	64	CB102PB	126	SL575ALP	73
8890410	53	8891509	60	8892401	64	CB120PB	126	SL576ALP	73
8890500	67	8891600	62	8892410	64	CB150	126	SL585ALP	71
8890501	67	8891602	62	8892411	64	CB150PB	126	SL585BLP	71
8890510	67	8891605	62	8892420	64	CB151	126	SL620ALP	73
8890600	54	8891700	62	8892425	64	CB151PB	126	SL630A	73
8890601	54	8891701	62	8892426	64	CB152PB	126	SL640ALP	75
8891001	77	8891702	62	8892600	57	CB200PB	126	SL645ALP	71
8891002	77	8891705	62	8892602	57	CB201	126	SL650A	75
8891003	77	8891706	62	8892609	57	CB201PB	126	SL65AO	69
8891004	60	8891709	62	8892620	57	CB202PB	126	SL65CO	69
8891006	60	8891710	62	8892700	61	CB251PB	126	SL660A	75
8891007	60	8891711	62	8892701	61	CB300	126	SL665A	71
8891010	46	8891800	63	8892703	61	CB30PB	126	SL66AC	69
8891015	63	8891900	56	8892704	61	CB50	126	SL66AG	69
8891016	119	8891901	56	8892709	61	CB50PB	126	SL66AO	69
8891017	119	8891902	56	8892800	61	CB60	126	SL66CA	69
8891018	119	8891903	56	8892801	61	CB60PB	126	SL66CG	69
8891022	47	8891904	56	8892802	61	CB62PB	126	SL66GO	69
8891026	47	8891909	56	8892805	61	CB80PB	126	SL675ALP	72
8891024	46	8891910	57	8892809	61	CB90PB	126	SL685ALP	72
8891025	46	8891911	57	8892810	61	CP202PB	126	SL695A	72
8891040	43	8891912	57	8892825	61	CT150RW	105	SL696A	72
8891042	43	8891913	57	8893024	38	CT150W12	105	SL700A	70
8891045	43	8891914	57	8893048	42	LB1	112	SL800A	70
8891049	43	8891919	57	8893049	38	LB1SS	112	SW700	124
8891050	43	8891920	56, 57	8893060	38	LB3163	110	SW710	125
8891052	43	8891921	56, 57	8893148	42	LB3163ALDT	110	SW901	125
8891060	44	8891925	56, 57	8894037	51	LB3163SST	110	SW911	125
8891062	44	8892003	66	8894047	51	LB3253	110	SW9111	125
8891068	44	8892010	66	8894050	51	LB3253ALDT	110	TL257M	120
8891080	44	8892013	66	8894055	51	LB3253SST	110		
8891082	44	8892102	56	8894056	51	LB383	109		
8891090	45	8892105	56	8894134	50	LB383ALDT	109		
8891091	45	8892106	56	8894142	50	LB383ALSM	109		
8891100	46	8892107	56	8895095	48	LB383P	109		
8891102	46	8892108	56	8895100	48	LB383SL	109		
8891104	60	8892109	56	8895105	48	LB383SST	109		
8891105	60	8892140	54	8895115	48	LB384	109		
8891110	45	8892141	54	8895120	48	LB384SST	109		
8891111	45	8892200	53	8895152	48	LB4663SST	108		
8891120	59	8892201	53	8895250	48	LB4773SST	108		
8891121	59	8892202	53	8895300	48	LB6123	111		
8891130	59	8892203	53	8895301	48	LB6123ALDT	111		
8891131	59	8892204	53	8895350	48	LB6123SST	111		





**TRAFFIC STICK LIGHTBARS**

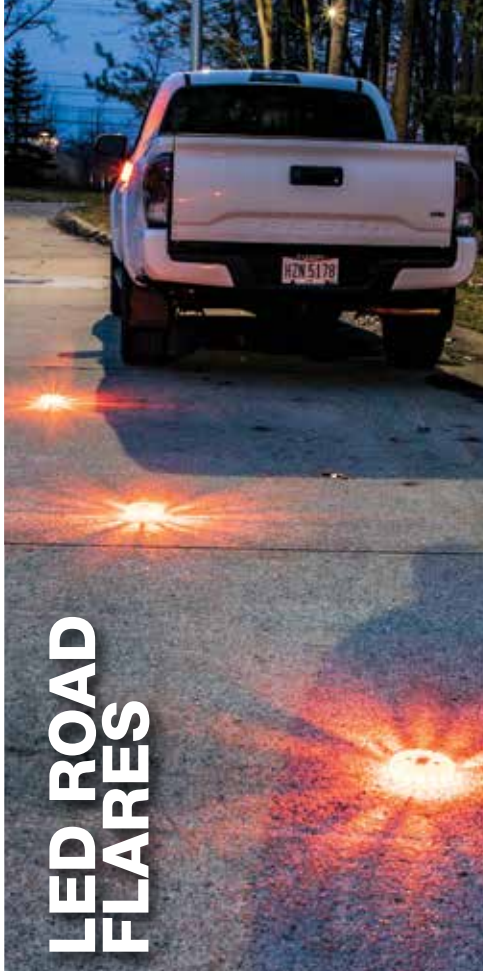

**LED ROAD FLARES**



**MODULAR LIGHTBARS**



**THIN MOUNT STROBES**



**EMERGENCY LIGHTS**



**MINI LIGHT BARS**



**LIGHT BAR KITS**



The Buyers family of manufacturing companies

**Tracom**

**B** Boomerang  
RUBBER, INC.

**R** RomoTech  
Rotational Molding Technologies, Inc.

**P** PROGRESSIVE  
POWDER COATING, INC.



[www.buyersproducts.com](http://www.buyersproducts.com)

**Buyers**  
PRODUCTS COMPANY

**SnowDogg**  
by Buyers

**SaltDogg**  
by Buyers

**ScoopDogg**  
by Buyers

**DumperDogg**  
by Buyers

LIGHTSLIT\_K